



Actuador

BT115A

- Para válvulas, con movimientos giratorios de 180°ng a la derecha y a la izquierda
- Cuatro conos de mando de distancias, fijos, reubicados en 90°

Actuador para la serie F31

Dimensiones

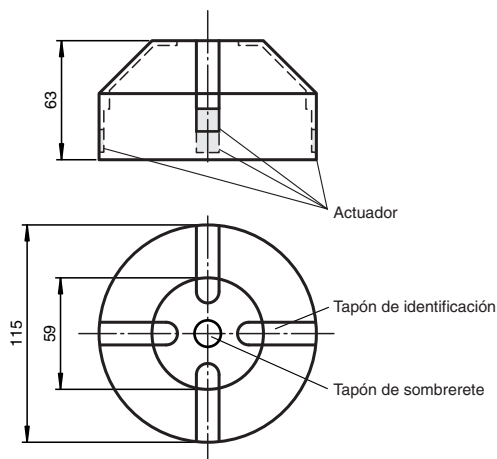

Datos técnicos

Datos generales

Diámetro de ondas	max. 110 mm
Colisis de fijación	max. 7 mm

Condiciones ambientales

Temperatura ambiente	-25 ... 70 °C (-13 ... 158 °F)
----------------------	--------------------------------

Datos mecánicos

Diámetro de ondas	< 90 mm
Altura de ondas	30 mm y 50 mm
Figura agujeros de fijación	30 x 130 mm

Material

Carcasa	Parte de fijación: PA
Disco de distancia	PA (2 piezas, grueso 10 mm)
Tapón de sombrerete	PE (1 pieza negra)
Tapón de identificación	PA (2 piezas amarillas, 2 piezas negras)
Tornillo de fijación	para actuador: 1.4305 / AISI 303 (1 pieza M6 x 25) para sensores -F31: 1.4305 / AISI 303 (4 piezas M5) (2 piezas M5 x 12)
Cono de mando	Acero inoxidable 1.4305 / AISI 303 (integrado)
Masa	120 g

Fecha de publicación: 2020-05-13 Fecha de edición: 2020-05-13 : 263361_spa.pdf

Consulte "Notas generales sobre la información de los productos de Pepperl+Fuchs".

Pepperl+Fuchs Group
www.pepperl-fuchs.com



















EE. UU.: +1 330 486 0001
fa-info@us.pepperl-fuchs.com

Alemania: +49 621 776 1111
fa-info@de.pepperl-fuchs.com

Singapur: +65 6779 9091
fa-info@sg.pepperl-fuchs.com

PEPPERL+FUCHS

Componentes del sistema adecuados

	NBN3-F31-E8-K	
	NBN3-F31-E8-K-K	
	NBN3-F31-E8-V1-Y7011-3680	
	NBN3-F31-E8-V1	
	NBN3-F31-E8-V1-FESTO	
	NBN3-F31-E8-V16-V15	
	NBN3-F31-E8-V18	
	NBN3-F31K-E8	
	NBN3-F31K-E8-K-FESTO	
	NBN3-F31K-E8-K	
	NBN3-F31K-E8-V1-V1	
	NBN3-F31K-Z8	
	NBN3-F31K-Z8-K-FESTO	
	NBN3-F31K-Z8-V1-V1	
	NBN3-F31K2-E8-B13-S	
	NBN3-F31K2-E8-B33-S	
	NBN3-F31K2-E8-B43-S	
	NBN3-F31K2M-E8-B13-S	
	NBN3-F31K2M-E8-B23-S	
	NBN3-F31K2M-E8-B33-S	
	NBN3-F31K2M-E8-B43-S	
	NBN3-F31K2M-Z8L-B43-S	

Fecha de publicación: 2020-05-13 Fecha de edición: 2020-05-13 : 263361_spa.pdf

Consulte "Notas generales sobre la información de los productos de Pepperl+Fuchs".

 Pepperl+Fuchs Group
 www.pepperl-fuchs.com





















 EE. UU.: +1 330 486 0001
 fa-info@us.pepperl-fuchs.com

 Alemania: +49 621 776 1111
 fa-info@de.pepperl-fuchs.com

 Singapur: +65 6779 9091
 fa-info@sg.pepperl-fuchs.com

 **PEPPERL+FUCHS**

Componentes del sistema adecuados

	NBN3-F31K2M-Z8L-B13-S	
	NCN3-F31K2M-N4-B23-S	
	NBN3-F31K2M-Z8L-B23-S	
	NBN3-F31K2M-Z8L-B33-S	
	NBN3-F31K2-Z8L-B13-S	
	NBN3-F31K2-Z8L-B13-S-Y300073	
	NBN3-F31K2-Z8L-B13-S-Y292890	
	NBN3-F31K2-Z8L-B33-S	
	NBN3-F31-U8-K	
	NBN3-F31-U8-V18	
	NBN3-F31-Z8-K	
	NBN3-F31-Z8-K-K	
	NBN3-F31-Z8-V1-FESTO	
	NBN3-F31-Z8-V18	
	NCN3-F31-B3B-V1	Indicador de retorno de válvulas y módulo de control p. válvulas
	NCN3-F31-B3B-V1-K	Indicador de retorno de válvulas y módulo de control p. válvulas
	NCN3-F31-B3B-V1-V1	Indicador de retorno de válvulas y módulo de control p. válvulas
	NCN3-F31-B3B-V1-V1-FESTO	Indicador de retorno de válvulas y módulo de control p. válvulas
	NCN3-F31-B3-V1-K	Indicador de retorno de válvulas y módulo de control p. válvulas
	NCN3-F31K-B3B-B31	Indicador de retorno de válvulas y módulo de control p. válvulas
	NCN3-F31K-N4	



















Fecha de publicación: 2020-05-13 Fecha de edición: 2020-05-13 : 263361_spa.pdf

Consulte "Notas generales sobre la información de los productos de Pepperl+Fuchs".

Pepperl+Fuchs Group
www.pepperl-fuchs.comEE. UU.: +1 330 486 0001
fa-info@us.pepperl-fuchs.comAlemania: +49 621 776 1111
fa-info@de.pepperl-fuchs.comSingapur: +65 6779 9091
fa-info@sg.pepperl-fuchs.com

PEPPERL+FUCHS

Componentes del sistema adecuados

	NCN3-F31K2-N5-B33-S
	NCN3-F31K2M-N4-B13-S
	NCN3-F31K2-N4-B33-S
	NCN3-F31K2-N5-B13-S
	NCN3-F31K-N4-B13
	NCN3-F31K2-N4-B13-S
	NCN3-F31K-N4-B13-S
	NCN3-F31K-N4-K-FESTO
	NCN3-F31K-N4-K
	NCN3-F31K-N4-K-S
	NCN3-F31K-N4-S
	NCN3-F31K-N4-V1-V1
	NCN3-F31K-N5-K
	NCN3-F31-N4-K
	NCN3-F31-N4-K-K
	NCN3-F31-N4-V1-FESTO
	NCN3-F31-N4-V1
	NCN3-F31-N4-V16-K
	NCN3-F31-N4-V16-V16
	NCN3-F31-N4-V18

Fecha de publicación: 2020-05-13 Fecha de edición: 2020-05-13 : 263361_spa.pdf

Consulte "Notas generales sobre la información de los productos de Pepperl+Fuchs".

Pepperl+Fuchs Group
www.pepperl-fuchs.comEE. UU.: +1 330 486 0001
fa-info@us.pepperl-fuchs.comAlemania: +49 621 776 1111
fa-info@de.pepperl-fuchs.comSingapur: +65 6779 9091
fa-info@sg.pepperl-fuchs.com PEPPERL+FUCHS

Función

El activador está fabricado en un material plástico conductor que evita la carga estática y permite la instalación en entornos potencialmente explosivos.