

ESTANTERIA PALETIZACION

MOD.GC

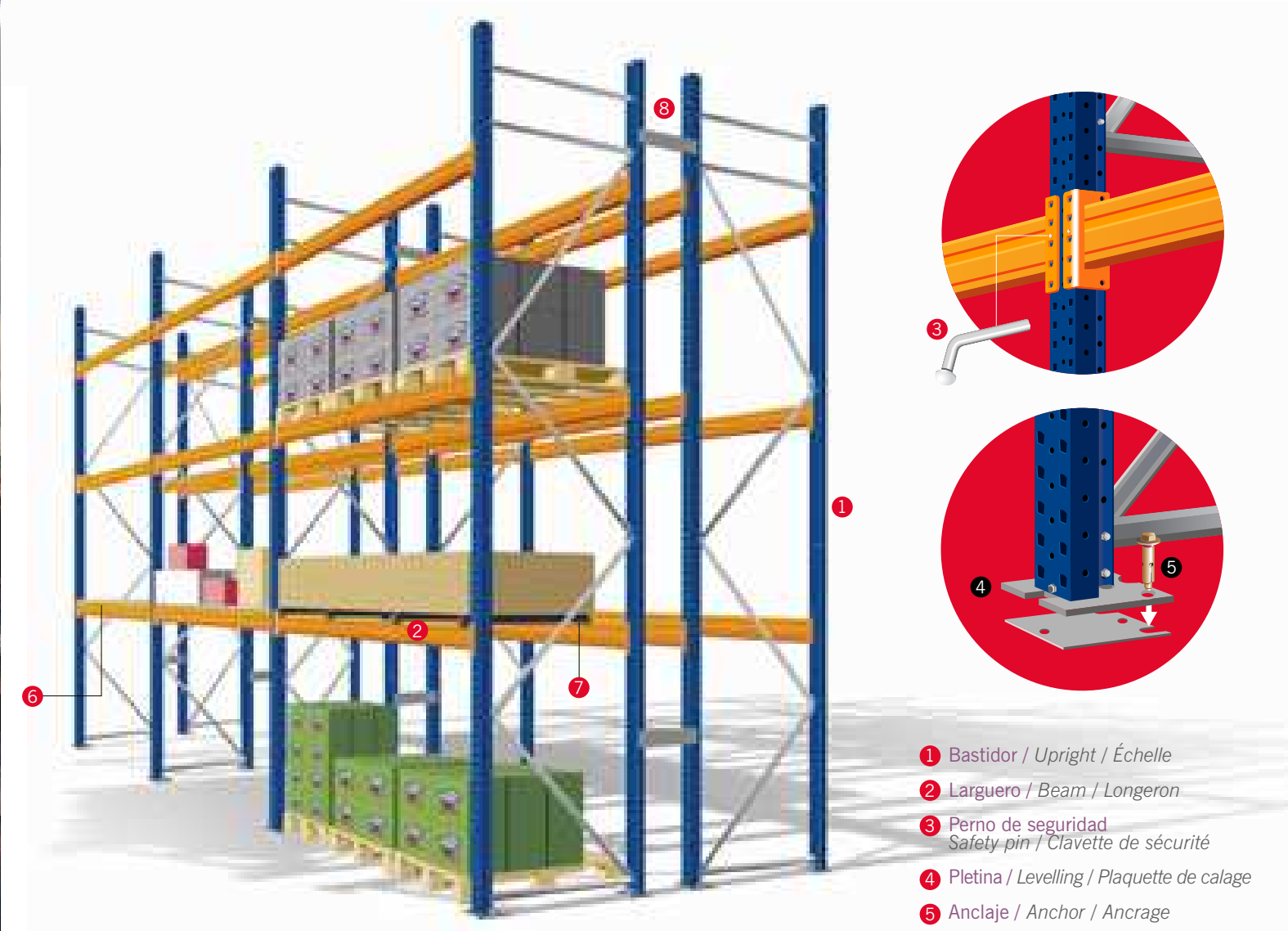

- 1 Bastidor / Upright / Échelle
- 2 Larguero / Beam / Longeron
- 3 Perno de seguridad / Safety pin / Clavette de sécurité
- 4 Pletina / Levelling / Plaquette de calage
- 5 Anclaje / Anchor / Ancrage
- 6 Travesaño exterior aglomerado / External chipboard cross member / Traverse extérieure agglomérée
- 7 Travesaño elevado / Raised cross member / Traverse élevée
- 8 Unión bifrontal / Bi-frontal attachment / Union bifrontale

Paletización convencional, la respuesta apropiada al almacenaje de productos paletizados con un gran número de referencias, permitiendo, con su configuración estructural, un acceso directo a cada paleta sin necesidad de desplazar o mover otras.

Conventional palletization, the ideal solution for storing palletized goods with a large number of references. The structural layout allows direct access to each pallet without having to move others.

La palettisation conventionnelle, la réponse adaptée au stockage de produits palettisés comprenant un grand nombre de références, permettant, grâce à sa configuration structurelle, l'accès direct à chaque palette sans avoir à en déplacer d'autres.





larguero CC2 / CC2 beam / longeron CC2

Artículo L Item L/Article L	Peso k Weight k/Poids k	Referencia Reference/Référence	€/Unidad €/Unit/€/Unité
CC2 80 / 1825	9,675	77010029	29,01
CC2 100 / 1825	10,439	77010104	31,92
CC2 80 / 2225	11,341	77010030	34,41
CC2 100 / 2225	12,389	77010105	37,89
CC2 80 / 2700	13,342	77010031	40,47
CC2 100 / 2700	14,704	77010106	44,61
CC2 120 / 2700	15,976	77010256	48,48
CC2 140 / 2700	17,247	77010331	52,74
CC2 150 / 2700	17,883	77010406	54,69
CC2 150 / 3300	21,515	77010407	65,79

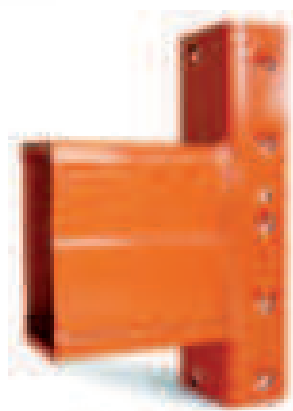

RAL 2004 naranja / orange

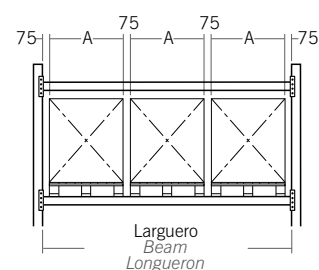
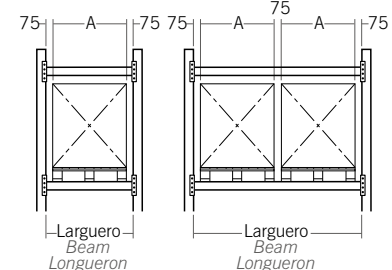
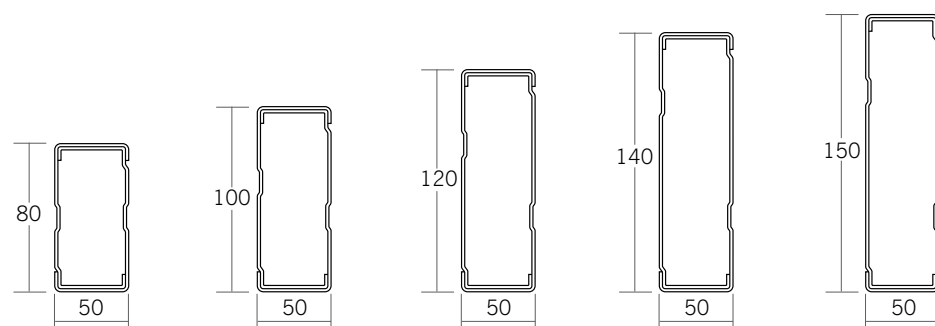

Larguero Beam Longeron	L / 950	L / 1150	L / 1350	L / 1825	L / 2225	L / 2700	L / 3300
CC2 80	4300 k	3700 k	3300 k	2600 k	2200 k	1600 k	-
CC2 100	-	-	4100 k	3200 k	2700 k	2300 k	-
CC2 120	-	-	-	-	-	2800 k	2400 k
CC2 140	-	-	-	-	-	3200 k	2700 k
CC2 150	-	-	-	-	-	3400 k	3000 k

Capacidad de carga por par de largueros / Load capacity per pair of beams / Capacité de charge par couple de longérons

Nº de paletas No. of pallets Nº de palettes	Paleta Palet / Palette (A) 800 x 1200	Paleta Palet / Palette (A) 1000 x 1200	Paleta Palet / Palette (A) 1200 x 1200
1	(L) 950	(L) 1150	(L) 1350
2	(L) 1825	(L) 2225	(L) 2700
3	(L) 2700	(L) 3300	-

(L) Longitud larguero / (L) Length of beam / (L) Longueur du longeron

Instrucciones de montaje / assembly instructions / instructions de montage

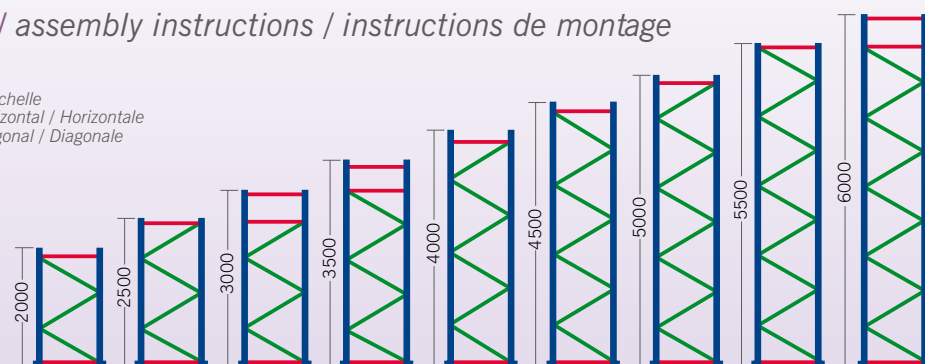

bastidor D80.20 / D80.20 upright / échelle D80.20

Artículo HxP Item HxD/Article HxP	Peso k Weight k/Poids k	Referencia Reference/Référence	€/Unidad €/Unit/€/Unité
2000 x 1050	24,540	77021121	72,24
2500 x 1050	29,850	77021122	87,09
3000 x 1050	35,071	77021124	101,67
3500 x 1050	40,381	77021126	116,52
4000 x 1050	44,552	77021127	128,19
4500 x 1050	49,861	77021129	143,01
5000 x 1050	55,171	77021131	157,86
5500 x 1050	60,481	77021132	172,71
6000 x 1050	65,702	77021134	187,29

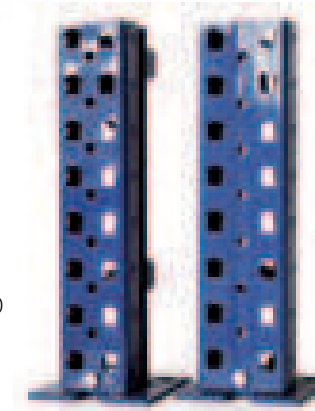
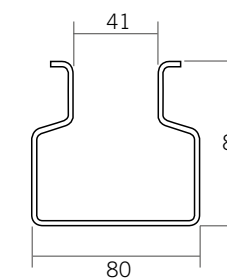

RAL 5010 azul / blue / bleu

bastidor D100.20 / D100.20 upright / échelle D100.20

Artículo HxP Item HxD/Article HxP	Peso k Weight k/Poids k	Referencia Reference/Référence	€/Unidad €/Unit/€/Unité
4000 x 1050	49,324	77021055	141,51
4500 x 1050	55,231	77021057	157,74
5000 x 1050	61,137	77021059	174,24
5500 x 1050	67,043	77021060	190,71
6000 x 1050	72,861	77021062	206,94

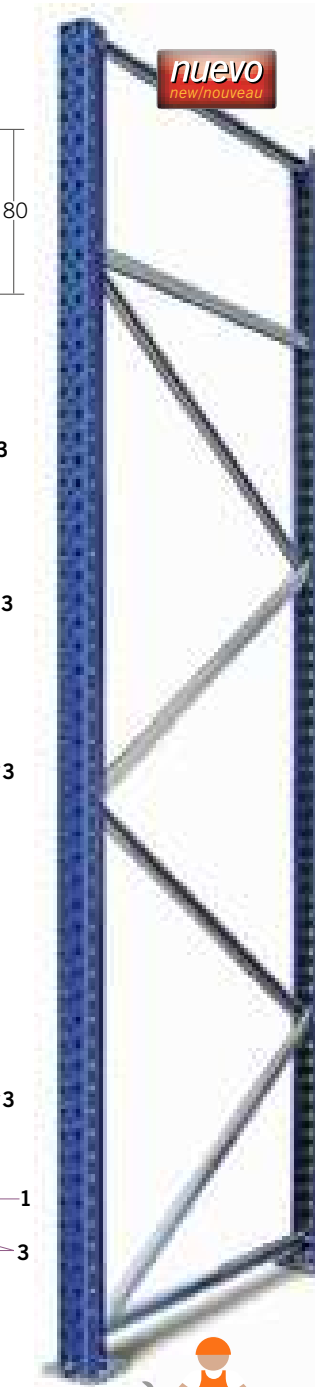
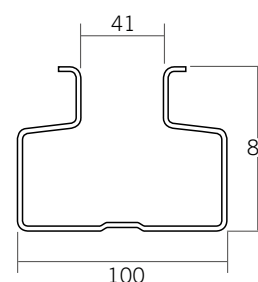

Bastidores en fondo 700 y 850, consultar / Uprights with 700 and 850 depth, please consult / Echelles de fond 700 et 850, consulter

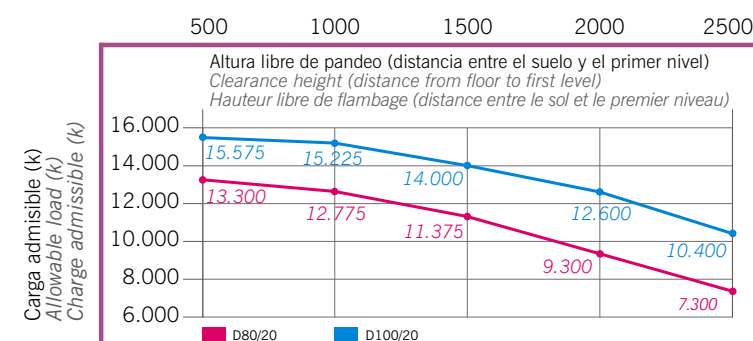

- Tornillo M10 x 20 DIN-933.8.8 / Bolt / Boulon
- Tornillo M10 x 60 DIN-933.8.8 / Bolt / Boulon
- Tuerca M10 DIN-985.8 / Nut / Écrou
- Distanciador Ø 16/13 L= 38 mm / Separator / Séparateur
- Distanciador Ø 16/13 L= 28 mm / Separator / Séparateur
- Tuerca M10 DIN-934.8 / Nut / Écrou
- Pie metálico / Footplate / Pied métallique
- Puntal de bastidor / Upright profile / Montant du échelle
- Diagonal vertical / Vertical diagonal / Diagonale verticale
- Diagonal horizontal / Horizontal diagonal / Diagonale horizontale

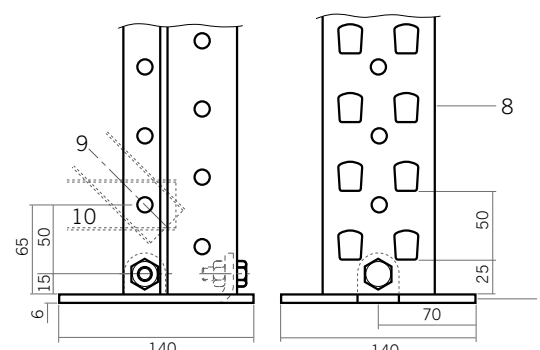



galvanizado / galvanized / galvanisée

Artículo Item Article	Peso k Weight k Poids k	Referencia Reference Référence	€/Unidad €/Unit €/Unité
Perno de seguridad / Larguero Safety pin / Beam Clavette de sécurité / Longeron	0,011	77000001	0,09
Pletina de nivelación 1,5 mm Levelling plate 1,5 mm Plaquette de calage 1,5 mm	0,218	77000008	1,38
M10 x 70 anclaje / Suelo M10 x 70 Anchor / Floor Ancrage M10 x 70 / Sol	0,080	77000034	1,13



nuevo
new/nouveau

RAL 1003 amarillo / yellow / jaune

Artículo Item Article	Peso k Weight k Poids k	Referencia Reference Référence	€/Unidad €/Unit €/Unité
Protección bastidor Upright protection Protection échelle	8,385	77000030	44,14
Protección lateral 1150 mm Side protection 1150 mm Protection latérale 1150 mm	6,178	77000032	33,00
Protección lateral 2500 mm Side protection 2500 mm Protection latérale 2500 mm	19,478	77000033	106,14
Anclaje M16 x 110 / Protector M16 x 110 anchor / Protector Ancrage M16 x 110 / Protecteur	0,279	77000035	5,03



Tornillería incluida. Anclajes no incluidos / Screws included. Anchors not included / Visserie inclus. Ancrages non inclus

galvanizado / galvanized / galvanisée

Artículo Item Article	Peso k Weight k Poids k	Referencia Reference Référence	€/Unidad €/Unit €/Unité
Unión a pared 100 mm Attachment to wall 100 mm Union au mur 100 mm	0,214	77000037	3,59
Unión a pared 200 mm Attachment to wall 200 mm Union au mur 200 mm	0,356	77000038	3,86
Unión a pared 300 mm Attachment to wall 300 mm Union au mur 300 mm	0,490	77000039	4,14
Unión bifrontal 300 mm Bi-frontal attachment 300 mm Union bifrontale 300 mm	0,490	77000048	4,14



Tornillería incluida / Bolts included / Boulons fournis



Unión a pared
Attachment to wall / Union au mur



Unión bifrontal
Bi-frontal attachment / Union bifrontale

Artículo Item Article	Peso k Weight k Poids k	Referencia Reference Référence	€/Unidad €/Unit €/Unité
Travesaño exterior aglomerado 1050 mm External chipboard cross member 1050 mm Traverse extérieure agglomérée 1050 mm	3,213	77000053	13,09
Travesaño interior paleta 1050 mm Internal pallet cross member 1050 mm Traverse intérieure palette 1050 mm	4,120	77000056	15,29

referencia / reference / référence: 77000053
galvanizado / galvanized / galvanisée



referencia / reference / référence: 77000056
RAL 5010 azul / blue / bleu

RAL 5010 azul / blue / bleu

Artículo Item Article	Peso k Weight k Poids k	Referencia Reference Référence	€/Unidad €/Unit €/Unité
Travesaño elevado 1050 mm Raised cross member 1050 mm Traverse élevée 1050 mm	4,680	77000059	16,39

