

PUNTAS DE ATORNILLAR

Puntas intercambiables de atornillar Plus - TiN - DIATiN

Portapuntas magnéticos, de cambio rápido y con anillo magnético frontal

Vasos magnéticos hexagonales

Atornillador de carraca con puntas de atornillar

Estuches de puntas de atornillar

Extractores de máquina para tornillos rotos y estuches

Extractores de mano para tornillos rotos y estuches

Herramientas con mango hexagonal 1/4"

Brocas para metal

Macho de roscar

Avellanador para metal

Broca para pared serie profesional

Broca para madera





25mm
LONG.
TOTAL
(L₁)



408

Puntas de atornillar

Rosa

PHILLIPS



€x Punta		2 Uds		5 Uds		50 Uds		100 Uds	
	L ₁ mm		€		€		€		€
Ph 0	25	Ph0-2	2,11	Ph0-5	1,81	Ph0-50	1,54	Ph0-100	1,49
Ph 1	25	Ph1-2	0,78	Ph1-5	0,61	Ph1-50	0,52	Ph1-100	0,48
Ph 2	25	Ph2-2	0,78	Ph2-5	0,61	Ph2-50	0,52	Ph2-100	0,48
Ph 3	25	Ph3-2	0,78	Ph3-5	0,61	Ph3-50	0,52	Ph3-100	0,48
Ph 4	25	Ph4-2	3,11	Ph4-5	2,73	Ph4-50	2,61	Ph4-100	-

POZIDRIV



€x Punta		2 Uds		5 Uds		50 Uds		100 Uds	
	L ₁ mm		€		€		€		€
Pz 0	25	Pz0-2	2,11	Pz0-5	1,81	Pz0-50	1,54	Pz0-100	1,49
Pz 1	25	Pz1-2	0,78	Pz1-5	0,61	Pz1-50	0,52	Pz1-100	0,48
Pz 2	25	Pz2-2	0,78	Pz2-5	0,61	Pz2-50	0,52	Pz2-100	0,48
Pz 3	25	Pz3-2	0,78	Pz3-5	0,61	Pz3-50	0,52	Pz3-100	0,48
Pz 4	25	Pz4-2	2,87	Pz4-5	2,73	Pz4-50	2,61	Pz4-100	-

PHILLIPS
REDUCIDA



€x Punta		2 Uds		5 Uds		50 Uds		100 Uds	
	L ₁ mm		€		€		€		€
Ph 1R	25	Ph1R-2	2,46	Ph1R-5	2,11	Ph1R-50	1,96	Ph1R-100	-
Ph 2R	25	Ph2R-2	2,46	Ph2R-5	2,11	Ph2R-50	1,96	Ph2R-100	-
Ph 3R	25	Ph3R-2	2,46	Ph3R-5	2,11	Ph3R-50	1,96	Ph3R-100	-

POZIDRIV
REDUCIDA



€x Punta		2 Uds		5 Uds		50 Uds		100 Uds	
	L ₁ mm		€		€		€		€
Pz 1R	25	Pz1R-2	2,46	Pz1R-5	2,11	Pz1R-50	1,96	Pz1R-100	-
Pz 2R	25	Pz2R-2	2,46	Pz2R-5	2,11	Pz2R-50	1,96	Pz2R-100	-
Pz 3R	25	Pz3R-2	2,46	Pz3R-5	2,11	Pz3R-50	1,96	Pz3R-100	-



93 699 46 04



pedidos@suministrosgrado.com www.suministrosgrado.com



Puntas de atornillar
Rosa

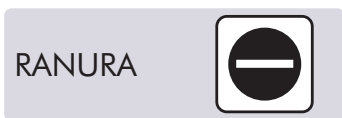

€x Punta		2 Uds		5 Uds		50 Uds		100 Uds	
	L1 mm		€		€		€		€
0,5X3,0	25	P0,5X3,0-2	1,42	P0,5X3,0-5	1,17	P0,5X3,0-50	1,12	P0,5X3,0-100	1,04
0,6X3,5	25	P0,6X3,5-2	1,42	P0,6X3,5-5	1,17	P0,6X3,5-50	1,12	P0,6X3,5-100	1,04
0,5X4,0	25	P0,5X4,0-2	1,42	P0,5X4,0-5	1,17	P0,5X4,0-50	1,12	P0,5X4,0-100	1,04
0,6X4,5	25	P0,6X4,5-2	1,42	P0,6X4,5-5	1,17	P0,6X4,5-50	1,12	P0,6X4,5-100	1,04
0,8X4,0	25	P0,8X4,0-2	1,42	P0,8X4,0-5	1,17	P0,8X4,0-50	1,12	P0,8X4,0-100	1,04
0,8X5,0	25	P0,8X5,0-2	1,42	P0,8X5,0-5	1,17	P0,8X5,0-50	1,12	P0,8X5,0-100	1,04
0,8X5,5	25	P0,8X5,5-2	1,42	P0,8X5,5-5	1,17	P0,8X5,5-50	1,12	P0,8X5,5-100	1,04
1,0X5,5	25	P1X5,5-2	1,42	P1X5,5-5	1,17	P1X5,5-50	1,12	P1X5,5-100	1,04
1,0X6,0	25	P1X6,0-2	1,42	P1X6,0-5	1,17	P1X6,0-50	1,12	P1X6,0-100	1,04
1,2X6,5	25	P1,2X6,5-2	1,42	P1,2X6,5-5	1,17	P1,2X6,5-50	1,12	P1,2X6,5-100	1,04
1,2X8,0	25	P1,2X8,0-2	1,42	P1,2X8,0-5	1,17	P1,2X8,0-50	1,12	P1,2X8,0-100	1,04



€x Punta		2 Uds		5 Uds		50 Uds		100 Uds	
	L1 mm		€		€		€		€
T5	25	PT5-2	1,86	PT5-5	1,54	PT5-50	1,39	PT5-100	1,29
T6	25	PT6-2	1,86	PT6-5	1,54	PT6-50	1,39	PT6-100	1,29
T7	25	PT7-2	1,86	PT7-5	1,54	PT7-50	1,39	PT7-100	1,29
T8	25	PT8-2	1,86	PT8-5	1,54	PT8-50	1,39	PT8-100	1,29
T9	25	PT9-2	1,86	PT9-5	1,54	PT9-50	1,39	PT9-100	1,29
T10	25	PT10-2	1,69	PT10-5	1,12	PT10-50	1,04	PT10-100	0,99
T15	25	PT15-2	1,69	PT15-5	1,12	PT15-50	1,04	PT15-100	0,99
T20	25	PT20-2	1,69	PT20-5	1,12	PT20-50	1,04	PT20-100	0,99
T25	25	PT25-2	1,69	PT25-5	1,12	PT25-50	1,04	PT25-100	0,99
T27	25	PT27-2	1,69	PT27-5	1,12	PT27-50	1,04	PT27-100	0,99
T30	25	PT30-2	1,69	PT30-5	1,12	PT30-50	1,04	PT30-100	0,99
T40	25	PT40-2	1,69	PT40-5	1,12	PT40-50	1,04	PT40-100	0,99



€x Punta		2 Uds		5 Uds		50 Uds		100 Uds	
	L1 mm		€		€		€		€
TR10	25	PTR10-2	7,70	PTR10-5	7,51	PTR10-50	5,84	PTR10-100	5,70
TR15	25	PTR15-2	7,70	PTR15-5	7,51	PTR15-50	5,84	PTR15-100	5,70
TR20	25	PTR20-2	7,70	PTR20-5	7,51	PTR20-50	5,84	PTR20-100	5,70
TR25	25	PTR25-2	7,70	PTR25-5	7,51	PTR25-50	5,84	PTR25-100	5,70
TR30	25	PTR30-2	7,70	PTR30-5	7,51	PTR30-50	5,84	PTR30-100	5,70
TR40	25	PTR40-2	7,70	PTR40-5	7,51	PTR40-50	5,84	PTR40-100	5,70



€x Punta		2 Uds		5 Uds		50 Uds		100 Uds	
	L1 mm		€		€		€		€
Nº1	25	PC1-2	2,86	PC1-5	2,71	PC1-50	2,61	PC1-100	2,56
Nº2	25	PC2-2	2,86	PC2-5	2,71	PC2-50	2,61	PC2-100	2,56
Nº3	25	PC3-2	2,86	PC3-5	2,71	PC3-50	2,61	PC3-100	2,56



93 699 46 04



pedidos@suministrosgrado.com www.suministrosgrado.com



TORX DE SEGURIDAD



€x Punta		2 Uds		5 Uds		50 Uds		100 Uds	
	L1 mm		€		€		€		€
TS10	25	PTS10-2	2,81	PTS10-5	2,51	PTS10-50	2,36	PTS10-100	2,16
TS15	25	PTS15-2	2,81	PTS15-5	2,51	PTS15-50	2,36	PTS15-100	2,16
TS20	25	PTS20-2	2,81	PTS20-5	2,51	PTS20-50	2,36	PTS20-100	2,16
TS25	25	PTS25-2	2,81	PTS25-5	2,51	PTS25-50	2,36	PTS25-100	2,16
TS27	25	PTS27-2	2,81	PTS27-5	2,51	PTS27-50	2,36	PTS27-100	2,16
TS30	25	PTS30-2	2,81	PTS30-5	2,51	PTS30-50	2,36	PTS30-100	2,16
TS40	25	PTS40-2	2,81	PTS40-5	2,51	PTS40-50	2,36	PTS40-100	2,16

CABEZA HEXAGONAL



€x Punta		2 Uds		5 Uds		50 Uds		100 Uds	
	L1 mm		€		€		€		€
2 mm	25	PHX2-2	1,77	PHX2-5	1,69	PHX2-50	1,59	PHX2-100	1,49
2,5 mm	25	PHX2,5-2	1,77	PHX2,5-5	1,69	PHX2,5-50	1,59	PHX2,5-100	1,49
3 mm	25	PHX3-2	1,77	PHX3-5	1,69	PHX3-50	1,59	PHX3-100	1,49
4 mm	25	PHX4-2	1,77	PHX4-5	1,69	PHX4-50	1,59	PHX4-100	1,49
5 mm	25	PHX5-2	1,77	PHX5-5	1,69	PHX5-50	1,59	PHX5-100	1,49
6 mm	25	PHX6-2	1,77	PHX6-5	1,69	PHX6-50	1,59	PHX6-100	1,49
8 mm	25	PHX8-2	1,77	PHX8-5	1,69	PHX8-50	1,59	PHX8-100	1,49

TRI WING



€x Punta		2 Uds		5 Uds		50 Uds		100 Uds	
	L1 mm		€		€		€		€
Nº4	25	PTRW4-2	7,43	PTRW4-5	7,13	PTRW4-50	6,34	PTRW4-100	5,81
Nº5	25	PTRW5-2	7,43	PTRW5-5	7,13	PTRW5-50	6,34	PTRW5-100	5,81
Nº6	25	PTRW6-2	7,43	PTRW6-5	7,13	PTRW6-50	6,34	PTRW6-100	5,81
Nº8	25	PTRW8-2	7,43	PTRW8-5	7,13	PTRW8-50	6,34	PTRW8-100	5,81
Nº10	25	PTRW10-2	7,43	PTRW10-5	7,13	PTRW10-50	6,34	PTRW10-100	5,81

XZN



€x Punta		2 Uds		5 Uds		50 Uds		100 Uds	
	L1 mm		€		€		€		€
Nº4	25	PXZN4-2	4,95	PXZN4-5	4,37	PXZN4-50	4,17	PXZN4-100	4,00
Nº5	25	PXZN5-2	4,95	PXZN5-5	4,37	PXZN5-50	4,17	PXZN5-100	4,00
Nº6	25	PXZN6-2	4,95	PXZN6-5	4,37	PXZN6-50	4,17	PXZN6-100	4,00
Nº8	25	PXZN8-2	7,43	PXZN8-5	6,86	PXZN8-50	6,73	PXZN8-100	6,49
Nº10	25	PXZN10-2	7,43	PXZN10-5	6,86	PXZN10-50	6,73	PXZN10-100	6,49



Plus



50mm
LONG.
TOTAL
(L₁)



PHILLIPS



€x Punta		2 Uds		5 Uds		50 Uds	
	L ₁ mm		€		€		€
Ph 1	50	Ph1X50-2	2,44	Ph1X50-5	2,29	Ph1X50-50	2,14
Ph 2	50	Ph2X50-2	2,44	Ph2X50-5	2,29	Ph2X50-50	2,14
Ph 3	50	Ph3X50-2	2,44	Ph3X50-5	2,29	Ph3X50-50	2,14
Ph 4	50	Ph4X50-2	-	Ph4X50-5	-	Ph4X50-50	-

POZIDRIV



€x Punta		2 Uds		5 Uds		50 Uds	
	L ₁ mm		€		€		€
Pz 1	50	Pz1X50-2	2,44	Pz1X50-5	2,29	Pz1X50-50	2,14
Pz 2	50	Pz2X50-2	2,44	Pz2X50-5	2,29	Pz2X50-50	2,14
Pz 3	50	Pz3X50-2	2,44	Pz3X50-5	2,29	Pz3X50-50	2,14
Pz 4	50	Pz4X50-2	-	Pz4X50-5	-	Pz4X50-50	-

RANURA



€x Punta		2 Uds		5 Uds		50 Uds	
	L ₁ mm		€		€		€
0,5X4,0	50	P0,5X4,0X50-2	3,98	P0,5X4,0X50-5	3,87	P0,5X4,0X50-50	3,78
0,5X3,0	50	P0,5X3,0X50-2	3,98	P0,5X3,0X50-5	3,87	P0,5X3,0X50-50	3,78
0,6X3,5	50	P0,6X3,5X50-2	3,98	P0,6X3,5X50-5	3,87	P0,6X3,5X50-50	3,78
0,6X4,5	50	P0,6X4,5X50-2	3,98	P0,6X4,5X50-5	3,87	P0,6X4,5X50-50	3,78
0,8X4,0	50	P0,8X4,0X50-2	3,98	P0,8X4,0X50-5	3,87	P0,8X4,0X50-50	3,78
0,8X5,0	50	P0,8X5,0X50-2	3,98	P0,8X5,0X50-5	3,87	P0,8X5,0X50-50	3,78
0,8X5,5	50	P0,8X5,5X50-2	3,98	P0,8X5,5X50-5	3,87	P0,8X5,5X50-50	3,78
1X5,5	50	P1X5,5X50-2	3,98	P1X5,5X50-5	3,87	P1X5,5X50-50	3,78
1X6,0	50	P1X6,0X50-2	3,98	P1X6,0X50-5	3,87	P1X6,0X50-50	3,78
1,2X6,5	50	P1,2X6,5X50-2	3,98	P1,2X6,5X50-5	3,87	P1,2X6,5X50-50	3,78
1,2X8,0	50	P1,2X8,0X50-2	3,98	P1,2X8,0X50-5	3,87	P1,2X8,0X50-50	3,78



€x Punta		2 Uds		5 Uds		50 Uds	
	L1 mm		€		€		€
T 5	50	PT5X50-2	5,00	PT5X50-5	4,85	PT5X50-50	4,77
T 6	50	PT6X50-2	5,00	PT6X50-5	4,85	PT6X50-50	4,77
T 7	50	PT7X50-2	5,00	PT7X50-5	4,85	PT7X50-50	4,77
T 8	50	PT8X50-2	5,00	PT8X50-5	4,85	PT8X50-50	4,77
T 9	50	PT9X50-2	5,00	PT9X50-5	4,85	PT9X50-50	4,77
T 10	50	PT10X50-2	3,85	PT10X50-5	3,75	PT10X50-50	3,68
T 15	50	PT15X50-2	3,85	PT15X50-5	3,75	PT15X50-50	3,68
T 20	50	PT20X50-2	3,85	PT20X50-5	3,75	PT20X50-50	3,68
T 25	50	PT25X50-2	3,85	PT25X50-5	3,75	PT25X50-50	3,68
T 27	50	PT27X50-2	3,85	PT27X50-5	3,75	PT27X50-50	3,68
T 30	50	PT30X50-2	3,85	PT30X50-5	3,75	PT30X50-50	3,68
T 40	50	PT40X50-2	3,85	PT40X50-5	3,75	PT40X50-50	3,68



€x Punta		2 Uds		5 Uds		50 Uds	
	L1 mm		€		€		€
Nº1	50	PC1X50-2	4,95	PC1X50-5	4,89	PC1X50-50	4,82
Nº2	50	PC2X50-2	4,95	PC2X50-5	4,89	PC2X50-50	4,82
Nº3	50	PC3X50-2	4,95	PC3X50-5	4,89	PC3X50-50	4,82

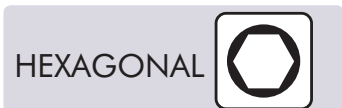

€x Punta		2 Uds		5 Uds		50 Uds	
	L1 mm		€		€		€
2mm	50	PHX2X50-2	4,40	PHX2X50-5	4,32	PHX2X50-50	4,20
2,5mm	50	PHX2,5X50-2	4,40	PHX2,5X50-5	4,32	PHX2,5X50-50	4,20
3mm	50	PHX3X50-2	4,40	PHX3X50-5	4,32	PHX3X50-50	4,20
4mm	50	PHX4X50-2	4,40	PHX4X50-5	4,32	PHX4X50-50	4,20
5mm	50	PHX5X50-2	4,40	PHX5X50-5	4,32	PHX5X50-50	4,20
6mm	50	PHX6X50-2	4,40	PHX6X50-5	4,32	PHX6X50-50	4,20
8mm	50	PHX8X50-2	5,59	PHX8X50-5	5,54	PHX8X50-50	5,44

Plus



70mm
LONG.
TOTAL
(L₁)



PHILLIPS



€x Punta		2 Uds		5 Uds	
	L ₁ mm		€		€
Ph 1	70	Ph1X70-2	5,35	Ph1X70-5	5,14
Ph 2	70	Ph2X70-2	5,35	Ph2X70-5	5,14
Ph 3	70	Ph3X70-2	5,35	Ph3X70-5	5,14
Ph 4	70	Ph4X70-2	-	Ph4X70-5	-

POZIDRIV



€x Punta		2 Uds		5 Uds	
	L ₁ mm		€		€
Pz 1	70	Pz1X70-2	5,35	Pz1X70-5	5,14
Pz 2	70	Pz2X70-2	5,35	Pz2X70-5	5,14
Pz 3	70	Pz3X70-2	5,35	Pz3X70-5	5,14
Pz 4	70	Pz4X70-2	-	Pz4X70-5	-

Plus



90mm
LONG.
TOTAL
(L₁)



PHILLIPS



€x Punta		2 Uds		5 Uds	
	L ₁ mm		€		€
Ph 1	90	Ph1X90-2	5,86	Ph1X90-5	5,66
Ph 2	90	Ph2X90-2	5,86	Ph2X90-5	5,66
Ph 3	90	Ph3X90-2	5,86	Ph3X90-5	5,66
Ph 4	90	Ph4X90-2	-	Ph4X90-5	-

POZIDRIV



€x Punta		2 Uds		5 Uds	
	L ₁ mm		€		€
Pz 1	90	Pz1X90-2	5,86	Pz1X90-5	5,66
Pz 2	90	Pz2X90-2	5,86	Pz2X90-5	5,66
Pz 3	90	Pz3X90-2	5,86	Pz3X90-5	5,66
Pz 4	90	Pz4X90-2	-	Pz4X90-5	-

TiN



25mm
LONG. TOTAL (L₁)



PHILLIPS 



€x Punta		2 Uds		5 Uds		50 Uds	
	L ₁ mm		€		€		€
Ph 1	25	Ph1T-2	1,72	Ph1T-5	1,44	Ph1T-50	1,27
Ph 2	25	Ph2T-2	1,72	Ph2T-5	1,44	Ph2T-50	1,27
Ph 3	25	Ph3T-2	1,72	Ph3T-5	1,44	Ph3T-50	1,27

POZIDRIV 



€x Punta		2 Uds		5 Uds		50 Uds	
	L ₁ mm		€		€		€
Pz 1	25	Pz1T-2	1,72	Pz1T-5	1,44	Pz1T-50	1,27
Pz 2	25	Pz2T-2	1,72	Pz2T-5	1,44	Pz2T-50	1,27
Pz 3	25	Pz3T-2	1,72	Pz3T-5	1,44	Pz3T-50	1,27

RANURA 



€x Punta		2 Uds		5 Uds		50 Uds	
	L ₁ mm		€		€		€
0,6X4,5	25	P0,6X4,5T-2	2,11	P0,6X4,5T-5	1,86	P0,6X4,5T-50	1,79
0,8X5,5	25	P0,8X5,5T-2	2,11	P0,8X5,5T-5	1,86	P0,8X5,5T-50	1,79
1X5,5	25	P1X5,5T-2	2,11	P1X5,5T-5	1,86	P1X5,5T-50	1,79
1,2X6,5	25	P1,2X6,5T-2	2,11	P1,2X6,5T-5	1,86	P1,2X6,5T-50	1,79

TORX 



€x Punta		2 Uds		5 Uds		50 Uds	
	L ₁ mm		€		€		€
T 10	25	PT10T-2	2,37	PT10T-5	2,07	PT10T-50	1,98
T 15	25	PT15T-2	2,37	PT15T-5	2,07	PT15T-50	1,98
T 20	25	PT20T-2	2,37	PT20T-5	2,07	PT20T-50	1,98
T 25	25	PT25T-2	2,37	PT25T-5	2,07	PT25T-50	1,98
T 27	25	PT27T-2	2,37	PT27T-5	2,07	PT27T-50	1,98
T 30	25	PT30T-2	2,37	PT30T-5	2,07	PT30T-50	1,98
T 40	25	PT40T-2	2,37	PT40T-5	2,07	PT40T-50	1,98



TiN



50mm
LONG. TOTAL (L₁)



PHILLIPS



€ x Punta		2 Uds		5 Uds		50 Uds	
	L ₁ mm		€		€		€
Ph 1	50	Ph1Tx50-2	4,75	Ph1Tx50-5	4,62	Ph1Tx50-50	4,47
Ph 2	50	Ph2Tx50-2	4,75	Ph2Tx50-5	4,62	Ph2Tx50-50	4,47
Ph 3	50	Ph3Tx50-2	4,75	Ph3Tx50-5	4,62	Ph3Tx50-50	4,47

POZIDRIV



€ x Punta		2 Uds		5 Uds		50 Uds	
	L ₁ mm		€		€		€
Pz 1	50	Pz1Tx50-2	4,75	Pz1Tx50-5	4,62	Pz1Tx50-50	4,47
Pz 2	50	Pz2Tx50-2	4,75	Pz2Tx50-5	4,62	Pz2Tx50-50	4,47
Pz 3	50	Pz3Tx50-2	4,75	Pz3Tx50-5	4,62	Pz3Tx50-50	4,47

TORX



€ x Punta		2 Uds		5 Uds		50 Uds	
	L ₁ mm		€		€		€
T 10	50	PT10Tx50-2	7,44	PT10Tx50-5	7,15	PT10Tx50-50	6,95
T 15	50	PT15Tx50-2	7,44	PT15Tx50-5	7,15	PT15Tx50-50	6,95
T 20	50	PT20Tx50-2	7,44	PT20Tx50-5	7,15	PT20Tx50-50	6,95
T 25	50	PT25Tx50-2	7,44	PT25Tx50-5	7,15	PT25Tx50-50	6,95
T 27	50	PT27Tx50-2	7,44	PT27Tx50-5	7,15	PT27Tx50-50	6,95
T 30	50	PT30Tx50-2	7,44	PT30Tx50-5	7,15	PT30Tx50-50	6,95
T 40	50	PT40Tx50-2	7,44	PT40Tx50-5	7,15	PT40Tx50-50	6,95

Puntas de atornillar
Rosa



PHILLIPS 



€x Punta		2 Uds		5 Uds		50 Uds	
	L1 mm		€		€		€
Ph 1	25	Ph1D-2	3,95	Ph1D-5	3,60	Ph1D-50	3,53
Ph 2	25	Ph2D-2	3,95	Ph2D-5	3,60	Ph2D-50	3,53
Ph 3	25	Ph3D-2	3,95	Ph3D-5	3,60	Ph3D-50	3,53

POZIDRIV 



€x Punta		2 Uds		5 Uds		50 Uds	
	L1 mm		€		€		€
Pz 1	25	Pz1D-2	3,95	Pz1D-5	3,60	Pz1D-50	3,53
Pz 2	25	Pz2D-2	3,95	Pz2D-5	3,60	Pz2D-50	3,53
Pz 3	25	Pz3D-2	3,95	Pz3D-5	3,60	Pz3D-50	3,53

RANURA 



€x Punta		2 Uds		5 Uds		50 Uds	
	L1 mm		€		€		€
0,6X4,5	25	P0,6X4,5D-2	4,90	P0,6X4,5D-5	4,80	P0,6X4,5D-50	4,65
0,8X5,5	25	P0,8X5,5D-2	4,90	P0,8X5,5D-5	4,80	P0,8X5,5D-50	4,65
1X5,5	25	P1X5,5D-2	4,90	P1X5,5D-5	4,80	P1X5,5D-50	4,65
1,2X6,5	25	P1,2X6,5D-2	4,90	P1,2X6,5D-5	4,80	P1,2X6,5D-50	4,65

TORX 



€x Punta		2 Uds		5 Uds		50 Uds	
	L1 mm		€		€		€
T 10	25	PT10D-2	6,66	PT10D-5	6,18	PT10D-50	5,86
T 15	25	PT15D-2	6,66	PT15D-5	6,18	PT15D-50	5,86
T 20	25	PT20D-2	6,66	PT20D-5	6,18	PT20D-50	5,86
T 25	25	PT25D-2	6,66	PT25D-5	6,18	PT25D-50	5,86
T 27	25	PT27D-2	6,66	PT27D-5	6,18	PT27D-50	5,86
T 30	25	PT30D-2	6,66	PT30D-5	6,18	PT30D-50	5,86
T 40	25	PT40D-2	6,66	PT40D-5	6,18	PT40D-50	5,86

PORTAPUNTAS MAGNÉTICOS

	L1 mm	TIPO DE MANGO	€
PMGx51	51	MAGNÉTICO SIN ANILLO	4,83
PMGx58	58	MAGNÉTICO SIN ANILLO	4,96
PMGx74	74	MAGNÉTICO CON ANILLO	11,00
PMGx100	100	MAGNÉTICO CON ANILLO	12,70
PMGx200	200	MAGNÉTICO CON ANILLO	20,34
PMGx250	250	MAGNÉTICO CON ANILLO	24,32
PMGSDSx78	78	SDS PLUS	21,49
PBERx74	74	BERILIO	44,61
PDESSx70	70	5/16" DESSOUTTER	27,49
P5,5x72	72	5.5mm Bosch	34,10
P7x74	74	7mm Fein	29,86



PORTAPUNTAS MAGNÉTICO CON CAMBIO RÁPIDO (APTO PARA PUNTAS DE 1/4" CON CUELLO)

	L1 mm	TIPO DE MANGO	€
PCR60 *	60	Cambio rápido 1/4" Apto para puntas de 1/4" con cuello	13,90
PCR74 *	74	Cambio rápido 1/4" Apto para puntas de 1/4" con cuello	14,33
PCRSDSX80	80	SDS PLUS	28,19
PCRDESSX70	70	Cambio dessoutter	38,05
PCR5,5X72	72	Cambio 5.5mm Bosch	38,05
PCR7X4	74	Cambio Fein 7mm	38,05



*  1 kg

PORTAPUNTAS MAGNÉTICO CON ANILLO MAGNÉTICO FRONTAL ADICIONAL PARA SUJECIÓN DE TORNILLOS



	L1 mm	TIPO DE MANGO	€
PCTX60	60	Portapuntas con tope regulable	13,10
PCRTX60	60	Portapuntas cambio rápido	15,03



VASO HEXAGONAL MAGNÉTICO



€ x Vaso	mm		2 Uds
	mm	"	€
PLIHX5-2	5,0		7,09
PLIHX5,5-2	5,5		7,09
PLIHX6-2	6,0		7,09
PLIHX1/4-2		1/4"=6,35	6,78
PLIHX7-2	7,0		6,78
PLIHX5/16-2		5/16"=7,93	6,78
PLIHX8-2	8,0		6,78
PLIHX3/8-2		3/8"=9,52	7,96
PLIHX10-2	10,0		7,06
PLIHX11-2	11,0		7,96
PLIHX12-2	12,0		7,96
PLIHX13-2	13,0		7,96

ESTUCHES DE 7 PIEZAS DE VASOS MAGNÉTICOS HEXAGONALES



REFERENCIA	EPLL
Nº LLAVES	7
CONTENIDO	HX1/4 - HX7 - HX8 - HX3/8 HX10 - HX12 - HX13
P.V.P. €	49,84

DESTORNILLADOR DE CARRACA CON ALMACÉN DE PUNTAS Y EXPOSITOR PARA DESTORNILLADORES



1. Alta calidad y rendimiento
2. Giro a derechas y a izquierdas
3. Caña telescópica ajustable en longitud
4. Fabricado en acero y plástico de alta resistencia

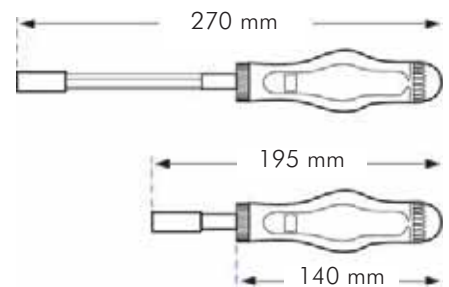

DTRC	
Contenido del destornillador	<ul style="list-style-type: none"> ⊕ PH1 - PH2 ⊕ PZ1 - PZ2 ★ T15 - T20 - T25 - T30
	27,95

EXDTRC	
	Expositor con 12 Destornilladores
	Ref. DTRC
	335,45

ESTUCHES DE 7 PIEZAS CALIDAD PLUS, TiN Y DIATiN



Ref. EPT1

REFERENCIA	EPT1	EPT2	EPT3
Nº PIEZAS			
CONTENIDO	+ PH1 - PH2 + PZ1 - PZ2 - 0,8x5,5 - 1,2x6,5 1 Portapuntas PMG	T10 - T15 ☆ T20 - T25 T30 - T40 1 Portapuntas PMG	+ PH1 - PH2 - PH3 + PZ1 - PZ2 - PZ3 1 Portapuntas PMG
P.V.P. €	9,72	13,11	11,66



Ref. EPTT1

REFERENCIA	EPTT1	EPTT2	EPTT3
Nº PIEZAS	7	7	7
CONTENIDO	+ PH1 - PH2 + PZ1 - PZ2 - 0,8x5,5 - 1,2x6,5 1 Portapuntas PMG	T10 - T15 ☆ T20 - T25 T30 - T40 1 Portapuntas PMG	+ PH1 - PH2 - PH3 + PZ1 - PZ2 - PZ3 1 Portapuntas PMG
P.V.P. €	27,59	31,99	26,60



Ref. EPTD1

REFERENCIA	EPTD1	EPTD2	EPTD3
Nº PIEZAS	7	7	7
CONTENIDO	+ PH1 - PH2 + PZ1 - PZ2 - 0,8x5,5 - 1,2x6,5 1 Portapuntas PMG	T10 - T15 ☆ T20 - T25 T30 - T40 1 Portapuntas PMG	+ PH1 - PH2 - PH3 + PZ1 - PZ2 - PZ3 1 Portapuntas PMG
P.V.P. €	40,21	45,17	38,18

ESTUCHES DE 12 PIEZAS CALIDAD PLUS, TiN Y DIATiN



Ref. EPT4

REFERENCIA	EPT4	EPT5
Nº PIEZAS	12	12
CONTENIDO	+ PH1 - PH2(2) - PH3 + PZ1 - PZ2(2) - PZ3 - 0,6x4,5 - 0,8x5,5 - 1,2x6,5 1 Portapuntas PMG	T10 - T15(2) ☆ T20(2) - T25(2) T27 - T30(2) - T40 1 Portapuntas PMG
P.V.P. €	13,04	17,91



Ref. EPTT4

REFERENCIA	EPTT4	EPTT5
Nº PIEZAS	12	12
CONTENIDO	+ PH1 - PH2(2) - PH3 + PZ1 - PZ2(2) - PZ3 - 0,6x4,5 - 0,8x5,5 - 1,2x6,5 1 Portapuntas PCT	T10 - T15(2) ☆ T20(2) - T25(2) T27 - T30(2) - T40 1 Portapuntas PCT
P.V.P. €	34,73	40,87



Ref. EPTD4

REFERENCIA	EPTD4	EPTD5
Nº PIEZAS	12	12
CONTENIDO	+ PH1 - PH2(2) - PH3 + PZ1 - PZ2(2) - PZ3 - 0,6x4,5 - 0,8x5,5 - 1,2x6,5 1 Portapuntas PCR	T10 - T15(2) ☆ T20(2) - T25(2) T27 - T30(2) - T40 1 Portapuntas PCR
P.V.P. €	54,10	62,94



ESTUCHES DE 31 PIEZAS CALIDAD PLUS, TiN Y DIATiN

Ref. EPT6



REFERENCIA	EPT6	
Nº PIEZAS	31	
CONTENIDO	<ul style="list-style-type: none"> ⊕ PH1(3) - PH2(3) - PH3(3) ⊕ PZ1(3) - PZ2(3) - PZ3(3) ⊖ 0,6x4,5 - 0,8x5,5 - 1,2x6,5 	<ul style="list-style-type: none"> ★ T10 - T15 - T20 - T25 - T30 - T40 ○ H3 - H4 - H5 1 Portapuntas PMG
P.V.P. €	37,28	

REFERENCIA	EPTT6	
Nº PIEZAS	31	
CONTENIDO	<ul style="list-style-type: none"> ⊕ PH1(3) - PH2(3) - PH3(3) ⊕ PZ1(3) - PZ2(3) - PZ3(3) ⊖ 0,6x4,5 - 0,8x5,5 - 1,2x6,5 	<ul style="list-style-type: none"> ★ T10 - T15 - T20 - T25 - T30 - T40 ○ H3 - H4 - H5 1 Portapuntas PCT
P.V.P. €	79,10	

REFERENCIA	EPTD6	
Nº PIEZAS	31	
CONTENIDO	<ul style="list-style-type: none"> ⊕ PH1(3) - PH2(3) - PH3(3) ⊕ PZ1(3) - PZ2(3) - PZ3(3) ⊖ 0,6x4,5 - 0,8x5,5 - 1,2x6,5 	<ul style="list-style-type: none"> ★ T10 - T15 - T20 - T25 - T30 - T40 ○ H3 - H4 - H5 1 Portapuntas PCR
P.V.P. €	134,19	

ESTUCHES DE 36 PIEZAS CALIDAD PLUS Y TiN



Ref. EPT7



Ref. EPTT7

REFERENCIA	EPT7	
Nº PIEZAS	36	
CONTENIDO	<ul style="list-style-type: none"> ⊕ PH1(3) - PH2(3) - PH3(3) ⊕ PZ1(3) - PZ2(3) - PZ3(3) ⊖ 0,5 x 4 - 0,6 x 4,5 - 0,8 x 5 - 0,8 x 5,5 - 1 x 6 - 1,2 x 6,5 - 1,2 x 8 	<ul style="list-style-type: none"> ★ T10 - T15 - T20 - T25 - T27 - T30 - T40 ○ H2 - H2,5 - H3 - H4 - H5 - H6 - H8 1 Portapuntas PMG
P.V.P. €	47,21	

REFERENCIA	EPTT7	
Nº PIEZAS	36	
CONTENIDO	<ul style="list-style-type: none"> ⊕ PH1(3) - PH2(3) - PH3(3) ⊕ PZ1(3) - PZ2(3) - PZ3(3) ⊖ 0,5 x 4 - 0,6 x 4,5 - 0,8 x 5 - 0,8 x 5,5 - 1 x 6 - 1,2 x 6,5 - 1,2 x 8 	<ul style="list-style-type: none"> ★ T10 - T15 - T20 - T25 - T27 - T30 - T40 ○ H2 - H2,5 - H3 - H4 - H5 - H6 - H8 1 Portapuntas PCT
P.V.P. €	96,87	

ESTUCHES DE 45 Y 80 PIEZAS CALIDAD Plus



Ref. EPT45



Ref. EPT80



REFERENCIA	EPT45	
Nº PIEZAS	45	
CONTENIDO	<ul style="list-style-type: none"> PH1(2) - PH2(2) - PH3(2) PZ1(2) - PZ2(2) - PZ3(2) 0,5x3-0,6x4,5-0,8x5,5(2)-1,2x6,5-1,6x8 H2,5 - H3 - H4 - H5 - H6 - H7 T10 - T15 - T20 - T25 - T30 - T40 	<ul style="list-style-type: none"> Llaves de vasos Hexagonales (mm): 5 - 6 - 7 - 8 - 9 - 10 - 11 - 12 - 13 - 14 1 Adaptador de Vasos 1 Adaptador de Puntas 1 Portapuntas Magnético PCR 1 Llave de Carraca de 72 dientes 1 Destornillador
P.V.P. €	118,13	

REFERENCIA	EPT80	
Nº PIEZAS	80	
CONTENIDO	<ul style="list-style-type: none"> PH0 - PH1 - PH2(4) - PH3(2) PZ1 - PZ2(4) - PZ3(2) 0,5x3-0,6x4,5-0,8x5,5(2)-1,2x6,5-1,6x8 H2 - H2,5 - H3 - H4 - H5 - H6 - H7 - H8 TW1 - TW2 - TW3 - TW4 - TW5 TQ5 - TQ6 - TQ8 - TQ10 T5 - T6 - T7 - T8 - T9 - T10 - T15 T20(2) - T25(2) - T27 - T30 - T40 TS10 - TS15 - TS20 - TS25 - TS30 - TS40 	<ul style="list-style-type: none"> C0 - C1 - C2 - C3 SP4 - SP6 - SP8 - SP10 HS3 - HS4 - HS5 - HS6 1 Portapuntas Magnético PCR 1 Destornillador PH1 - PH2 PZ1 - PZ2 T15 - T20 - T25 - T30
P.V.P. €	140,81	

EXPOSITORES DE SOBREMESA PARA ESTUCHES DE 36 Y 80 PIEZAS



EXEPT7
10 Estuches de 36 piezas



Ref. EPT7

472,10



EXEPT7
10 Estuches de 36 piezas



Ref. EPT77

968,70



EXEPT80
5 Estuches de 80 piezas



Ref. EPT80

704,05



93 699 46 04



pedidos@suministrosrado.com www.suministrosrado.com

MICRO GRABIT    



EP		
		€
EP451C	M3	36,88
EP452C	M4	36,88
EP453C	M5	36,88
EP454C	M6	36,88

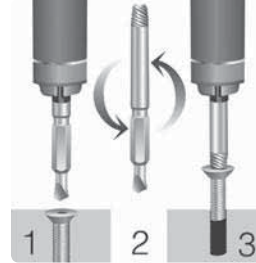

1. Taladrar el tornillo
2. Dar la vuelta.
3. Extraer

PRO GRABIT CON CUERPO HEXAGONAL 1/4"



EP		
		€
EP8401C	M5	29,26
EP8402C	M6	34,56
EP8403C	M8	34,56
EP8404C	M10	36,28

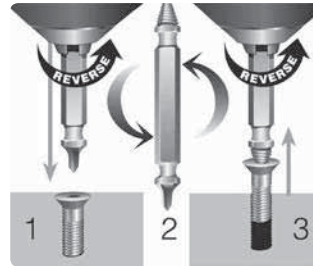

1. Taladrar el tornillo
2. Dar la vuelta.
3. Extraer

DRILL-OUT EXTRACTOR DE TORNILLOS ROTOS CON BROCA GUÍA (M6-M12)



EP		
		€
EP205C	M6	35,77
EP312C	M8	43,33
EP375C	M10	43,33
EP500C	M12	48,79

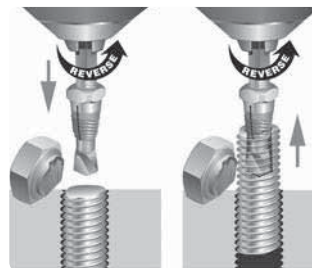

X-OUT EXTRACTOR DE TORNILLOS ROTOS CON MANGO HEXAGONAL (M3-M5)



EP		
		€
EP3701C	M3	29,26
EP3702C	M4	29,26
EP3703C	M5	32,52





REFERENCIA	EP450C
Nº PIEZAS	4
CONTENIDO	M3-M4-M5-M6
P.V.P. €	151,32



REFERENCIA	EP8420C	EP8430C	EP8440C
Nº PIEZAS	2	3	4
CONTENIDO	M5-M6	M5-M6-M8	M5-M6-M8-M10
P.V.P. €	61,86	90,21	123,81



REFERENCIA	EP401C
Nº PIEZAS	4
CONTENIDO	M6-M8-M10-M12
P.V.P. €	178,00



REFERENCIA	EP701C	EP100C
Nº PIEZAS	7	10
CONTENIDO	MICRO GRABIT (M3-M6) DRILL OUT (M8-M12)	X OUT (M3-M5)-MICRO GRABIT (M3-M6) DRILL OUT (M8-M12)
P.V.P. €	249,20	278,44

EXTRACTORES DE MANO PARA TORNILLOS ROTOS

JUEGOS DE EXTRACTORES CLÁSICOS DE TORNILLOS

Taladrar un agujero central con la broca Blue-Master recomendada; Introducir el extractor en el agujero, haciendo girar el extractor hacia la izquierda, hasta extraer el tornillo.

REFERENCIA	EX/1-5	EX/1-6	EX/1-8
Nº PIEZAS	5	6	8
CONTENIDO	M3 - M18	M3 - M24	M3 - M45
P.V.P. €	14,68	19,86	45,84



EXTRACTORES SUELTOS



	Para TORNILLOS	∅ mm	∅ mm	L1 mm	∅ _{min} mm	∅ _{max} mm	EX €
EX/1	M3 - M6	3,2	2,5	51	1,75	3,95	1,95
EX/2	M6 - M8	4,0	3,0	60	2,20	4,80	1,95
EX/3	M8 - M11	5,1	4,5	68	3,30	6,40	2,30
EX/4	M11 - M14	6,2	6,0	76	4,75	8,40	2,86
EX/5	M14 - M18	8,6	8,0	86	6,35	11,00	3,71
EX/6	M18 - M24	12,0	11,0	95	9,50	15,00	6,28
EX/7	M24 - M33	15,9	14,0	105	12,70	19,00	17,01
EX/8	M33 - M50	20,0	21,0	111	19,00	25,00	27,86





HERRAMIENTAS CON MANGO HEXAGONAL 1/4"

424

BROCA PARA METAL DIN 338

Ref. BH2

HSS

OX



	Ø mm	L1 x L2 mm		BH2 €
BH20300	3,00	61 x 33	1/4"	4,70
BH20400	4,00	75 x 43	1/4"	5,45
BH20500	5,00	86 x 52	1/4"	6,78
BH20600	6,00	93 x 57	1/4"	7,32
BH20700	7,00	109 x 69	1/4"	9,22
BH20800	8,00	117 x 75	1/4"	10,36
BH20900	9,00	125 x 81	1/4"	11,65
BH21000	10,00	133 x 87	1/4"	12,97

BROCA PARA METAL EXTRA CORTA

Ref. BC59

HSS-G



Disponible con mango hexagonal con cuello bajo demanda.

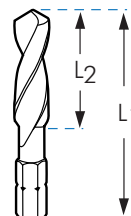

	Ø mm	L1 x L2 mm		BC59 €
BC590100	1,00	34 x 12	1/4"	5,37
BC590150	1,50	34 x 12	1/4"	5,37
BC590200	2,00	34 x 12	1/4"	5,37
BC590250	2,50	36 x 14	1/4"	5,37
BC590300	3,00	38 x 16	1/4"	5,37
BC590330	3,30	40 x 18	1/4"	5,37
BC590350	3,50	40 x 18	1/4"	5,37
BC590400	4,00	44 x 20	1/4"	5,37
BC590420	4,20	45 x 20	1/4"	5,37
BC590450	4,50	46 x 24	1/4"	5,37
BC590500	5,00	50 x 26	1/4"	5,37
BC590550	5,50	50 x 26	1/4"	5,86
BC590600	6,00	50 x 26	1/4"	5,86
BC590650	6,50	50 x 30	1/4"	5,86
BC590680	6,80	50 x 30	1/4"	5,86
BC590700	7,00	50 x 30	1/4"	5,86
BC590750	7,50	51 x 32	1/4"	6,63
BC590800	8,00	51 x 32	1/4"	6,63
BC590850	8,50	53 x 33	1/4"	6,63
BC590900	9,00	53 x 33	1/4"	8,01
BC590950	9,50	54 x 38	1/4"	8,01
BC591000	10,00	54 x 38	1/4"	8,01
BC591020	10,20	54 x 38	1/4"	8,01

BROCA BIDIAMETRAL

Ref. BH36

HSS

90°

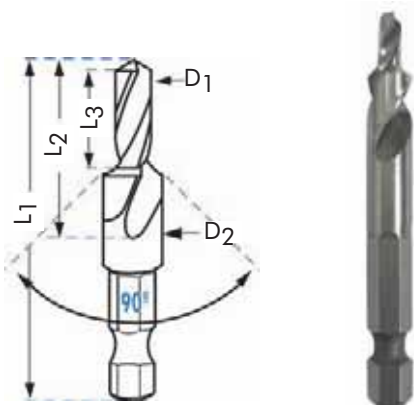
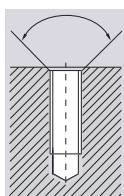

	D2 mm	D1 mm	L1 x L2 mm	L3 mm		BH36 €	
BH36M2	M2	2,3	1,6	35 x 6,5	5	1/4"	30,91
BH36M3	M3	3,4	2,5	47 x 10,4	8	1/4"	33,53
BH36M4	M4	4,5	3,3	53 x 14,3	11	1/4"	33,46
BH36M5	M5	5,5	4,2	59 x 16,9	13	1/4"	39,46
BH36M6	M6	6,6	5,0	59 x 16,9	16	1/4"	42,72
BH36M8	M8	9,0	6,8	70 x 26,0	20	1/4"	55,09



BROCA-MACHO AVELLANADOR

Ref. MAHM

HSS-G

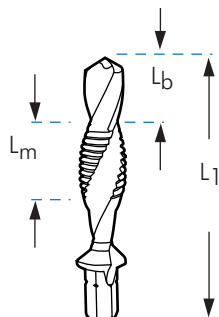
Disponible con mango hexagonal con cuello bajo demanda.

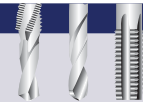

				MAHM
		$L_1 \times L_b \times L_m$ mm		€
M 3 x 0,50	36 x 5 x 6	1/4"	15,99	
M 4 x 0,70	39 x 6 x 7	1/4"	15,99	
M 5 x 0,80	41 x 8 x 8	1/4"	15,99	
M 6 x 1,00	44 x 8 x 10	1/4"	15,99	
M 8 x 1,25	50 x 10 x 11	1/4"	22,11	
M 10 x 1,50	59 x 11 x 11	1/4"	26,67	



MACHO HSS-G

Ref. M

HSS-G

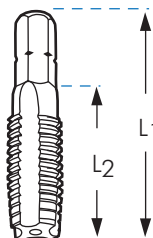
Disponible con mango hexagonal con cuello bajo demanda.



		$L_1 \times L_2$ mm		M
M 3 x 0,50	33 x 11	1/4"	5,96	
M 4 x 0,70	35 x 12	1/4"	5,96	
M 5 x 0,80	36 x 15	1/4"	7,59	
M 6 x 1,00	39 x 18	1/4"	7,59	
M 8 x 1,25	40 x 19	1/4"	10,51	
M 10 x 1,50	41 x 21	1/4"	12,98	

AVELLANADOR DE 3 CORTES

Ref. AV22

HSS-G

Disponible con mango hexagonal con cuello bajo demanda.

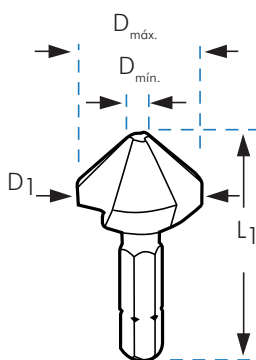

				AV22
D1 mm	L1 mm	D _{min.} - D _{max.} mm		€
6,30	31	1,50 - 5,8	1/4"	15,16
8,30	31	2,00 - 7,8	1/4"	15,16
10,40	34	2,50 - 10,0	1/4"	16,25
12,40	35	2,80 - 12,0	1/4"	17,33
16,50	40	3,20 - 16,0	1/4"	18,56
20,50	41	3,50 - 20,0	1/4"	22,28

AVELLANADOR PARA DESBARBAR

Ref. AV1...CR

HSS

 90°  1/4"

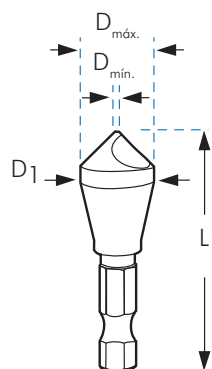

					AV1...CR
	D1 mm	L1 mm	D _{min.} - D _{max.} mm		€
AV101CR	10,00	45	2,0 - 5,0	1/4"	15,17
AV102CR	14,00	48	5,0 - 10,0	1/4"	18,96
AV103CR	20,00	65	10,0 - 15,0	1/4"	33,96
AV104CR	27,00	85	15,0 - 20,0	1/4"	60,66

Disponible broca avellanadora helicoidal y broca escalonada con mango hexagonal 1/4". Consultar páginas 132

HERRAMIENTAS CON MANGO HEXAGONAL 1/4"

426

Puntos de afornillar

Rosa

BROCA PARA PARED

Ref. BWH

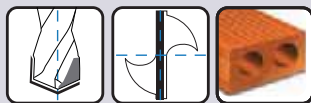

	Ø mm	L1 x L2 mm		BWH €
BWH03	3	70 x 30	1/4"	2,21
BWH04	4	70 x 30	1/4"	2,45
BWH05	5	85 x 45	1/4"	2,76
BWH06	6	100 x 50	1/4"	3,08
BWH07	7	100 x 50	1/4"	3,47
BWH08	8	120 x 70	1/4"	4,18
BWH09	9	120 x 70	1/4"	4,81
BWH10	10	120 x 70	1/4"	5,60
BWH11	11	150 x 80	1/4"	6,70
BWH12	12	150 x 80	1/4"	7,88
BWH13	13	150 x 80	1/4"	9,06
BWH14	14	150 x 80	1/4"	10,55

BROCA PARA MADERA

Ref. BMH



	Ø mm	L1 x L2 mm		BMH €
BMH03	3	59 x 35	1/4"	1,34
BMH04	4	74 x 41	1/4"	1,42
BMH05	5	82 x 55	1/4"	1,40
BMH06	6	88 x 58	1/4"	1,89
BMH07	7	110 x 70	1/4"	2,14
BMH08	8	110 x 70	1/4"	2,23
BMH09	9	110 x 70	1/4"	2,32
BMH10	10	115 x 75	1/4"	2,57
BMH11	11	135 x 85	1/4"	3,00
BMH12	12	135 x 85	1/4"	3,52
BMH13	13	135 x 90	1/4"	5,51
BMH14	14	145 x 95	1/4"	6,86



REFERENCIA	BWH9318	BWH9327	BWH9319	BMH9335	BMH9333
Nº BROCAS	5	5	8	5	8
APLICACIÓN	PARED	PARED	PARED	MADERA	MADERA
CONTENIDO	Ø 3-4-5-6-8 mm	Ø 4-5-6-8-10 mm	Ø 3-4-5-6-7-8-9-10 mm	Ø 3-4-5-6-8 mm	Ø 3-4-5-6-7-8-9-10 mm
P.V.P. €	19,53	24,04	26,98	11,55	15,23

ESTUCHES DE HERRAMIENTAS CON MANGO HEXAGONAL 1/4"



Ref. EB



Ref. EMBP

CONTENIDO

	 HSS-G	 HSS-G			€
EM	M3 - M4 - M5 - M6 M8 - M10	-	-	-	49,66
EMBP	M3 - M4 - M5 - M6 M8 - M10	Ø 2,50 - 3,30 - 4,20 5 - 6,80 - 8,50	-	-	74,94
EBM	-	-	M3 - M4 - M5 - M6 M8 - M10	-	106,47
EA	-	-	-	Ø 6,30 - 8,30 - 10,40 12,40 - 16,50 - 20,50	100,23
EB	-	Ø 1 - 10 mm x 0,50	-	-	89,08



93 699 46 04



pedidos@suministrosgrado.com www.suministrosgrado.com