



Sistema EW - ECO 316

TARIRA 2018

DESCRIPCIÓN

Chimenea modular metálica para evacuación de humos y gases de los productos de la combustión de simple pared fabricada en acero inoxidable

MATERIAL

AISI 316L

ACABADO EXTERIOR

Brillante
Colores RAL hasta 200°C (consultar precios)

ESPEORES (mm)

0,4 - 0,5 - 0,6 (según el diámetro)

DIÁMETROS DISPONIBLES (mm)

80 - 100 - 130 - 150 - 180 - 200 - 250 - 300 - 350 - 400 - 450 - 500 - 550 - 600 - 650 - 700 - 750 - 800

SISTEMA DE UNIÓN

Conexión macho-hembra con **abrazadera de unión sencilla**



APLICACIONES

- Calderas y estufas de combustibles sólidos

CARACTERÍSTICAS

- Instalación por patinillo interior
- Temperatura de trabajo hasta 600°C
- **Soldadura TIG/LÁSER** en continuo en todas las piezas
- Abrazadera de unión **NO INCLUIDA**
- Posibilidad de **corte de módulos rectos a medida** en obra

CERTIFICADO CE

0036 CPD 9174 029

CLASIFICACIONES CE (UNE-EN 1856-1)

T600 - N1 - D - V2 - L50040 - G(100)

T400 - N1 - W - V2 - L50040 - O(50)

T200 - P1 - W - V2 - L50040 - O(00) (con junta de estanqueidad)



93 699 46 04



pedidos@suministrosrado.com www.suministrosrado.com



*con junta de estanqueidad



Módulo recto 1.000 mm



Módulo recto 500 mm



Módulo recto 250 mm



Módulo recto regulable 400 - 560 mm



Módulo recto regulable 560 - 920 mm

| Ø | CÓDIGO | € | CÓDIGO | € | CÓDIGO | € | CÓDIGO | € | CÓDIGO | € |
|-----|----------------|-------|----------------|-------|----------------|-------|-----------------|-------|-----------------|-------|
| 80 | 671-EWEC130080 | 24 € | 671-EWEC140080 | 17 € | 671-EWEC150080 | 13 € | 671-EWEC5440080 | 40 € | 671-EWEC5450080 | 48 € |
| 100 | 671-EWEC130100 | 29 € | 671-EWEC140100 | 18 € | 671-EWEC150100 | 14 € | 671-EWEC5440100 | 45 € | 671-EWEC5450100 | 53 € |
| 130 | 671-EWEC130130 | 39 € | 671-EWEC140130 | 21 € | 671-EWEC150130 | 15 € | 671-EWEC5440130 | 49 € | 671-EWEC5450130 | 60 € |
| 150 | 671-EWEC130150 | 43 € | 671-EWEC140150 | 23 € | 671-EWEC150150 | 16 € | 671-EWEC5440150 | 62 € | 671-EWEC5450150 | 74 € |
| 180 | 671-EWEC130180 | 50 € | 671-EWEC140180 | 26 € | 671-EWEC150180 | 17 € | 671-EWEC5440180 | 73 € | 671-EWEC5450180 | 88 € |
| 200 | 671-EWEC130200 | 56 € | 671-EWEC140200 | 31 € | 671-EWEC150200 | 18 € | 671-EWEC5440200 | 84 € | 671-EWEC5450200 | 101 € |
| 250 | 671-EWEC130250 | 73 € | 671-EWEC140250 | 39 € | 671-EWEC150250 | 20 € | 671-EWEC5440250 | 103 € | 671-EWEC5450250 | 124 € |
| 300 | 671-EWEC130300 | 88 € | 671-EWEC140300 | 46 € | 671-EWEC150300 | 24 € | 671-EWEC5440300 | 123 € | 671-EWEC5450300 | 150 € |
| 350 | 671-EWEC130350 | 118 € | 671-EWEC140350 | 60 € | 671-EWEC150350 | 28 € | 671-EWEC5440350 | 136 € | 671-EWEC5450350 | 163 € |
| 400 | 671-EWEC130400 | 133 € | 671-EWEC140400 | 65 € | 671-EWEC150400 | 30 € | 671-EWEC5440400 | 149 € | 671-EWEC5450400 | 181 € |
| 450 | 671-EWEC130450 | 162 € | 671-EWEC140450 | 90 € | 671-EWEC150450 | 47 € | 671-EWEC5440450 | 182 € | 671-EWEC5450450 | 200 € |
| 500 | 671-EWEC130500 | 193 € | 671-EWEC140500 | 119 € | 671-EWEC150500 | 70 € | 671-EWEC5440500 | 199 € | 671-EWEC5450500 | 224 € |
| 550 | 671-EWEC130550 | 222 € | 671-EWEC140550 | 138 € | 671-EWEC150550 | 84 € | 671-EWEC5440550 | 216 € | 671-EWEC5450550 | 249 € |
| 600 | 671-EWEC130600 | 240 € | 671-EWEC140600 | 144 € | 671-EWEC150600 | 85 € | 671-EWEC5440600 | 234 € | 671-EWEC5450600 | 273 € |
| 650 | 671-EWEC130650 | 253 € | 671-EWEC140650 | 150 € | 671-EWEC150650 | 86 € | 671-EWEC5440650 | 246 € | 671-EWEC5450650 | 287 € |
| 700 | 671-EWEC130700 | 316 € | 671-EWEC140700 | 188 € | 671-EWEC150700 | 108 € | 671-EWEC5440700 | 306 € | 671-EWEC5450700 | 358 € |
| 750 | 671-EWEC130750 | 329 € | 671-EWEC140750 | 195 € | 671-EWEC150750 | 112 € | 671-EWEC5440750 | 319 € | 671-EWEC5450750 | 374 € |
| 800 | 671-EWEC130800 | 358 € | 671-EWEC140800 | 213 € | 671-EWEC150800 | 122 € | 671-EWEC5440800 | 348 € | 671-EWEC5450800 | 408 € |



Módulo de descenso



Codo 15°



Codo 30°



Codo 45°



Codo 60°

| Ø | CÓDIGO | € | CÓDIGO | € | CÓDIGO | € | CÓDIGO | € | CÓDIGO | € |
|-----|------------------|-------|----------------|-------|----------------|-------|----------------|-------|----------------|-------|
| 80 | 671-EWEC14680080 | 39 € | 671-EWEC160080 | 13 € | 671-EWEC170080 | 13 € | 671-EWEC180080 | 13 € | 671-EWEC840080 | 17 € |
| 100 | 671-EWEC14680100 | 47 € | 671-EWEC160100 | 14 € | 671-EWEC170100 | 14 € | 671-EWEC180100 | 14 € | 671-EWEC840100 | 18 € |
| 130 | 671-EWEC14680130 | 63 € | 671-EWEC160130 | 16 € | 671-EWEC170130 | 16 € | 671-EWEC180130 | 16 € | 671-EWEC840130 | 20 € |
| 150 | 671-EWEC14680150 | 69 € | 671-EWEC160150 | 20 € | 671-EWEC170150 | 20 € | 671-EWEC180150 | 20 € | 671-EWEC840150 | 25 € |
| 180 | 671-EWEC14680180 | 82 € | 671-EWEC160180 | 25 € | 671-EWEC170180 | 25 € | 671-EWEC180180 | 25 € | 671-EWEC840180 | 30 € |
| 200 | 671-EWEC14680200 | 92 € | 671-EWEC160200 | 29 € | 671-EWEC170200 | 29 € | 671-EWEC180200 | 29 € | 671-EWEC840200 | 37 € |
| 250 | 671-EWEC14680250 | 120 € | 671-EWEC160250 | 34 € | 671-EWEC170250 | 34 € | 671-EWEC180250 | 34 € | 671-EWEC840250 | 45 € |
| 300 | 671-EWEC14680300 | 144 € | 671-EWEC160300 | 49 € | 671-EWEC170300 | 49 € | 671-EWEC180300 | 49 € | 671-EWEC840300 | 61 € |
| 350 | 671-EWEC14680350 | 193 € | 671-EWEC160350 | 69 € | 671-EWEC170350 | 69 € | 671-EWEC180350 | 69 € | 671-EWEC840350 | 80 € |
| 400 | 671-EWEC14680400 | 217 € | 671-EWEC160400 | 83 € | 671-EWEC170400 | 83 € | 671-EWEC180400 | 83 € | 671-EWEC840400 | 93 € |
| 450 | 671-EWEC14680450 | 264 € | 671-EWEC160450 | 123 € | 671-EWEC170450 | 123 € | 671-EWEC180450 | 123 € | 671-EWEC840450 | 139 € |
| 500 | 671-EWEC14680500 | 316 € | 671-EWEC160500 | 142 € | 671-EWEC170500 | 142 € | 671-EWEC180500 | 142 € | 671-EWEC840500 | 157 € |
| 550 | 671-EWEC14680550 | 362 € | 671-EWEC160550 | 165 € | 671-EWEC170550 | 165 € | 671-EWEC180550 | 165 € | 671-EWEC840550 | 173 € |
| 600 | 671-EWEC14680600 | 393 € | 671-EWEC160600 | 178 € | 671-EWEC170600 | 178 € | 671-EWEC180600 | 178 € | 671-EWEC840600 | 188 € |
| 650 | 671-EWEC14680650 | 415 € | 671-EWEC160650 | 186 € | 671-EWEC170650 | 186 € | 671-EWEC180650 | 186 € | - | - |
| 700 | 671-EWEC14680700 | 517 € | 671-EWEC160700 | 233 € | 671-EWEC170700 | 233 € | 671-EWEC180700 | 233 € | - | - |
| 750 | 671-EWEC14680750 | 540 € | 671-EWEC160750 | 241 € | 671-EWEC170750 | 241 € | 671-EWEC180750 | 241 € | - | - |
| 800 | 671-EWEC14680800 | 588 € | 671-EWEC160800 | 263 € | 671-EWEC170800 | 263 € | 671-EWEC180800 | 263 € | - | - |



93 699 46 04



pedidos@suministrosrado.com www.suministrosrado.com



Sistema EW - ECO 316



Codo 90°

Codo 90° Multidireccional
(N1) 0-90°

Te 90°



Te 135°



Colector de hollín

| Ø | CÓDIGO | € | CÓDIGO | € | CÓDIGO | € | CÓDIGO | € | CÓDIGO | € |
|-----|----------------|-------|-----------------|------|-----------------|-------|----------------|--------|-----------------|-------|
| 80 | 671-EWEC600080 | 18 € | 671-EWEC1010080 | 40 € | 671-EWEC3170080 | 38 € | 671-EWEC120080 | 45 € | 671-EWEC5510080 | 17 € |
| 100 | 671-EWEC600100 | 20 € | 671-EWEC1010100 | 40 € | 671-EWEC3170100 | 43 € | 671-EWEC120100 | 49 € | 671-EWEC5510100 | 18 € |
| 130 | 671-EWEC600130 | 23 € | 671-EWEC1010130 | 47 € | 671-EWEC3170130 | 50 € | 671-EWEC120130 | 52 € | 671-EWEC5510130 | 21 € |
| 150 | 671-EWEC600150 | 28 € | 671-EWEC1010150 | 56 € | 671-EWEC3170150 | 61 € | 671-EWEC120150 | 66 € | 671-EWEC5510150 | 23 € |
| 180 | 671-EWEC600180 | 34 € | 671-EWEC1010180 | 67 € | 671-EWEC3170180 | 63 € | 671-EWEC120180 | 78 € | 671-EWEC5510180 | 27 € |
| 200 | 671-EWEC600200 | 41 € | 671-EWEC1010200 | 77 € | 671-EWEC3170200 | 79 € | 671-EWEC120200 | 90 € | 671-EWEC5510200 | 29 € |
| 250 | 671-EWEC600250 | 51 € | 671-EWEC1010250 | 93 € | 671-EWEC3170250 | 93 € | 671-EWEC120250 | 111 € | 671-EWEC5510250 | 34 € |
| 300 | 671-EWEC600300 | 67 € | - | - | 671-EWEC3170300 | 110 € | 671-EWEC120300 | 141 € | 671-EWEC5510300 | 43 € |
| 350 | 671-EWEC600350 | 90 € | - | - | 671-EWEC3170350 | 132 € | 671-EWEC120350 | 155 € | 671-EWEC5510350 | 51 € |
| 400 | 671-EWEC600400 | 103 € | - | - | 671-EWEC3170400 | 152 € | 671-EWEC120400 | 170 € | 671-EWEC5510400 | 68 € |
| 450 | 671-EWEC600450 | 153 € | - | - | 671-EWEC3170450 | 237 € | 671-EWEC120450 | 263 € | 671-EWEC5510450 | 93 € |
| 500 | 671-EWEC600500 | 172 € | - | - | 671-EWEC3170500 | 288 € | 671-EWEC120500 | 306 € | 671-EWEC5510500 | 100 € |
| 550 | 671-EWEC600550 | 190 € | - | - | 671-EWEC3170550 | 364 € | 671-EWEC120550 | 384 € | 671-EWEC5510550 | 136 € |
| 600 | 671-EWEC600600 | 208 € | - | - | 671-EWEC3170600 | 414 € | 671-EWEC120600 | 888 € | 671-EWEC5510600 | 142 € |
| 650 | - | - | - | - | 671-EWEC3170650 | 436 € | 671-EWEC120650 | 939 € | 671-EWEC5510650 | 148 € |
| 700 | - | - | - | - | 671-EWEC3170700 | 542 € | 671-EWEC120700 | 1.168€ | 671-EWEC5510700 | 186 € |
| 750 | - | - | - | - | 671-EWEC3170750 | 565 € | 671-EWEC120750 | 1.221€ | 671-EWEC5510750 | 192 € |
| 800 | - | - | - | - | 671-EWEC3170800 | 617 € | 671-EWEC120800 | 1.331€ | 671-EWEC5510800 | 210 € |

Colector de hollín con
desagüeMódulo de inspección
L=330 mmMódulo temperatura
humos L=330 mmMódulo de inspección
con tapa 200 Pa (P1)Módulo de inspección
con tapa 40 Pa (N1)

| Ø | CÓDIGO | € | CÓDIGO | € | CÓDIGO | € | CÓDIGO | € | CÓDIGO | € |
|-----|----------------|-------|-----------------|-------|----------------|--------|-----------------|--------|----------------|-------|
| 80 | 671-EWEC440080 | 21 € | 671-EWEC5430080 | 22 € | 671-EWEC870080 | 127 € | 671-EWEC5490080 | 84 € | 671-EWEC680080 | 46 € |
| 100 | 671-EWEC440100 | 23 € | 671-EWEC5430100 | 25 € | 671-EWEC870100 | 131 € | 671-EWEC5490100 | 93 € | 671-EWEC680100 | 49 € |
| 130 | 671-EWEC440130 | 26 € | 671-EWEC5430130 | 27 € | 671-EWEC870130 | 158 € | 671-EWEC5490130 | 103 € | 671-EWEC680130 | 56 € |
| 150 | 671-EWEC440150 | 27 € | 671-EWEC5430150 | 34 € | 671-EWEC870150 | 195 € | 671-EWEC5490150 | 129 € | 671-EWEC680150 | 69 € |
| 180 | 671-EWEC440180 | 26 € | 671-EWEC5430180 | 41 € | 671-EWEC870180 | 234 € | 671-EWEC5490180 | 155 € | 671-EWEC680180 | 84 € |
| 200 | 671-EWEC440200 | 29 € | 671-EWEC5430200 | 46 € | 671-EWEC870200 | 269 € | 671-EWEC5490200 | 177 € | 671-EWEC680200 | 95 € |
| 250 | 671-EWEC440250 | 40 € | 671-EWEC5430250 | 56 € | 671-EWEC870250 | 335 € | 671-EWEC5490250 | 219 € | 671-EWEC680250 | 118 € |
| 300 | 671-EWEC440300 | 48 € | 671-EWEC5430300 | 67 € | 671-EWEC870300 | 402 € | 671-EWEC5490300 | 262 € | 671-EWEC680300 | 141 € |
| 350 | 671-EWEC440350 | 60 € | 671-EWEC5430350 | 73 € | 671-EWEC870350 | 442 € | 671-EWEC5490350 | 287 € | 671-EWEC680350 | 154 € |
| 400 | 671-EWEC440400 | 104 € | 671-EWEC5430400 | 80 € | 671-EWEC870400 | 486 € | 671-EWEC5490400 | 318 € | 671-EWEC680400 | 170 € |
| 450 | 671-EWEC440450 | 133 € | 671-EWEC5430450 | 115 € | 671-EWEC870450 | 530 € | 671-EWEC5490450 | 446 € | 671-EWEC680450 | 239 € |
| 500 | 671-EWEC440500 | 152 € | 671-EWEC5430500 | 136 € | 671-EWEC870500 | 576 € | 671-EWEC5490500 | 581 € | 671-EWEC680500 | 314 € |
| 550 | 671-EWEC440550 | 163 € | 671-EWEC5430550 | 144 € | 671-EWEC870550 | 628 € | 671-EWEC5490550 | 757 € | 671-EWEC680550 | 408 € |
| 600 | 671-EWEC440600 | 167 € | 671-EWEC5430600 | 153 € | 671-EWEC870600 | 678 € | 671-EWEC5490600 | 819 € | 671-EWEC680600 | 441 € |
| 650 | 671-EWEC440650 | 176 € | 671-EWEC5430650 | 160 € | 671-EWEC870650 | 717 € | 671-EWEC5490650 | 866 € | 671-EWEC680650 | 465 € |
| 700 | 671-EWEC440700 | 219 € | 671-EWEC5430700 | 200 € | 671-EWEC870700 | 892 € | 671-EWEC5490700 | 1.077€ | 671-EWEC680700 | 579 € |
| 750 | 671-EWEC440750 | 228 € | 671-EWEC5430750 | 208 € | 671-EWEC870750 | 932 € | 671-EWEC5490750 | 1.125€ | 671-EWEC680750 | 604 € |
| 800 | 671-EWEC440800 | 250 € | 671-EWEC5430800 | 227 € | 671-EWEC870800 | 1.017€ | 671-EWEC5490800 | 1.227€ | 671-EWEC680800 | 658 € |



93 699 46 04



pedidos@suministrosrado.com www.suministrosrado.com



*con junta de estanqueidad



Codo 90° con inspección P1



Terminal salida libre



Terminal anti-lluvia



Terminal anti-viento



Terminal horizontal con rejilla

| Ø | CÓDIGO | € | CÓDIGO | € | CÓDIGO | € | CÓDIGO | € | CÓDIGO | € |
|-----|------------------|-------|----------------|-------|-----------------|-------|-----------------|-------|-----------------|-------|
| 80 | 671-EWEC19AL0080 | 55 € | 671-EWEC320080 | 32 € | 671-EWEC5260080 | 44 € | 671-EWEC5270080 | 66 € | 671-EWEC5320080 | 37 € |
| 100 | 671-EWEC19AL0100 | 66 € | 671-EWEC320100 | 36 € | 671-EWEC5260100 | 49 € | 671-EWEC5270100 | 73 € | 671-EWEC5320100 | 40 € |
| 130 | 671-EWEC19AL0130 | 71 € | 671-EWEC320130 | 40 € | 671-EWEC5260130 | 55 € | 671-EWEC5270130 | 80 € | 671-EWEC5320130 | 45 € |
| 150 | 671-EWEC19AL0150 | 91 € | 671-EWEC320150 | 49 € | 671-EWEC5260150 | 69 € | 671-EWEC5270150 | 101 € | 671-EWEC5320150 | 55 € |
| 180 | 671-EWEC19AL0180 | 111 € | 671-EWEC320180 | 60 € | 671-EWEC5260180 | 83 € | 671-EWEC5270180 | 119 € | 671-EWEC5320180 | 67 € |
| 200 | 671-EWEC19A67100 | 137 € | 671-EWEC320200 | 67 € | 671-EWEC5260200 | 95 € | 671-EWEC5270200 | 138 € | 671-EWEC5320200 | 76 € |
| 250 | 671-EWEC19A67150 | 161 € | 671-EWEC320250 | 83 € | 671-EWEC5260250 | 117 € | 671-EWEC5270250 | 170 € | 671-EWEC5320250 | 93 € |
| 300 | 671-EWEC19AL0300 | 180 € | 671-EWEC320300 | 99 € | 671-EWEC5260300 | 140 € | 671-EWEC5270300 | 203 € | 671-EWEC5320300 | 112 € |
| 350 | 671-EWEC19AL0350 | 215 € | 671-EWEC320350 | 109 € | 671-EWEC5260350 | 154 € | 671-EWEC5270350 | 238 € | 671-EWEC5320350 | 122 € |
| 400 | 671-EWEC19AL0400 | 257 € | 671-EWEC320400 | 120 € | 671-EWEC5260400 | 169 € | 671-EWEC5270400 | 298 € | 671-EWEC5320400 | 135 € |
| 450 | 671-EWEC19AL0450 | 394 € | 671-EWEC320450 | 150 € | - | - | - | - | 671-EWEC5320450 | 169 € |
| 500 | 671-EWEC19AL0500 | 449 € | 671-EWEC320500 | 161 € | - | - | - | - | 671-EWEC5320500 | 182 € |
| 550 | 671-EWEC19AL0550 | 545 € | 671-EWEC320550 | 207 € | - | - | - | - | 671-EWEC5320550 | 234 € |
| 600 | 671-EWEC19AL0600 | 647 € | 671-EWEC320600 | 223 € | - | - | - | - | 671-EWEC5320600 | 252 € |
| 650 | - | - | 671-EWEC320650 | 234 € | - | - | - | - | 671-EWEC5320650 | 264 € |
| 700 | - | - | 671-EWEC320700 | 292 € | - | - | - | - | 671-EWEC5320700 | 330 € |
| 750 | - | - | 671-EWEC320750 | 304 € | - | - | - | - | 671-EWEC5320750 | 344 € |
| 800 | - | - | 671-EWEC320800 | 331 € | - | - | - | - | 671-EWEC5320800 | 375 € |



Terminal Gas



Terminal Gas Light*



Regulador de tiro (N1) (solo tiro natural)



Estabilizador de tiro (adaptador + clapeta)



Manguito hembra-hembra

| Ø | CÓDIGO | € | CÓDIGO | € | CÓDIGO | € | CÓDIGO | € | CÓDIGO | € |
|-----|------------------|--------|------------------|-------|-----------------|-------|-----------------|-------|-----------------|-------|
| 80 | - | - | 671-EWEC43500080 | 122 € | 671-EWEC5310080 | 78 € | 671-EWEC9700080 | 107 € | 671-EWEC6130080 | 9 € |
| 100 | - | - | 671-EWEC43500100 | 131 € | 671-EWEC5310100 | 77 € | 671-EWEC9700100 | 111 € | 671-EWEC6130100 | 13 € |
| 130 | 671-EWEC14540130 | 190 € | 671-EWEC43500130 | 142 € | 671-EWEC5310130 | 77 € | 671-EWEC9700130 | 113 € | 671-EWEC6130130 | 15 € |
| 150 | 671-EWEC14540150 | 211 € | 671-EWEC43500150 | 164 € | 671-EWEC5310150 | 90 € | 671-EWEC9700150 | 131 € | 671-EWEC6130150 | 18 € |
| 180 | 671-EWEC14540180 | 234 € | 671-EWEC43500180 | 180 € | 671-EWEC5310180 | 102 € | 671-EWEC9700180 | 136 € | 671-EWEC6130180 | 23 € |
| 200 | 671-EWEC14540200 | 295 € | 671-EWEC43500200 | 200 € | 671-EWEC5310200 | 118 € | 671-EWEC9700200 | 152 € | 671-EWEC6130200 | 24 € |
| 250 | 671-EWEC14540250 | 359 € | 671-EWEC43500250 | 265 € | 671-EWEC5310250 | 168 € | 671-EWEC9700250 | 162 € | 671-EWEC6130250 | 27 € |
| 300 | 671-EWEC14540300 | 411 € | 671-EWEC43500300 | 344 € | 671-EWEC5310300 | 226 € | 671-EWEC9700300 | 188 € | 671-EWEC6130300 | 30 € |
| 350 | 671-EWEC14540350 | 539 € | - | - | 671-EWEC5310350 | 259 € | 671-EWEC9700350 | 201 € | 671-EWEC6130350 | 37 € |
| 400 | 671-EWEC14540400 | 601 € | - | - | 671-EWEC5310400 | 335 € | 671-EWEC9700400 | 208 € | 671-EWEC6130400 | 49 € |
| 450 | 671-EWEC14540450 | 728 € | - | - | 671-EWEC5310450 | 390 € | 671-EWEC9700450 | 218 € | 671-EWEC6130450 | 57 € |
| 500 | 671-EWEC14540500 | 925 € | - | - | 671-EWEC5310500 | 452 € | 671-EWEC9700500 | 228 € | 671-EWEC6130500 | 71 € |
| 550 | 671-EWEC14540550 | 1.037€ | - | - | 671-EWEC5310550 | 465 € | 671-EWEC9700550 | 231 € | 671-EWEC6130550 | 115 € |
| 600 | 671-EWEC14540600 | 1.145€ | - | - | 671-EWEC5310600 | 448 € | 671-EWEC9700600 | 245 € | 671-EWEC6130600 | 132 € |
| 650 | 671-EWEC14540650 | 1.212€ | - | - | 671-EWEC5310650 | 526 € | 671-EWEC9700650 | 257 € | 671-EWEC6130650 | 137 € |
| 700 | 671-EWEC14540700 | 1.508€ | - | - | 671-EWEC5310700 | 644 € | 671-EWEC9700700 | 321 € | 671-EWEC6130700 | 171 € |
| 750 | 671-EWEC14540750 | 1.576€ | - | - | 671-EWEC5310750 | 745 € | 671-EWEC9700750 | 334 € | 671-EWEC6130750 | 178 € |
| 800 | 671-EWEC14540800 | 1.718€ | - | - | 671-EWEC5310800 | 909 € | 671-EWEC9700800 | 365 € | 671-EWEC6130800 | 193 € |

* En los diámetros Ø80 y Ø100 l.



93 699 46 04



pedidos@suministrosrado.com www.suministrosrado.com



Sistema EW - ECO 316



Manguito macho macho



Soporte de carga regulable L=220 mm



Placa base con desagüe lateral



Abrazadera de unión 1.0



Abrazadera fijación pared sencilla

| Ø | CÓDIGO | € | CÓDIGO | € | CÓDIGO | € | CÓDIGO | € | CÓDIGO | € |
|-----|-----------------|-------|-----------------|-------|---------------|-------|----------|------|-----------|-----|
| 80 | 671-EWEC9720080 | 9 € | 671-EWEC3790080 | 38 € | 671-EWEC60080 | 42 € | EW450080 | 4 € | EW5350080 | 7 € |
| 100 | 671-EWEC9720100 | 13 € | 671-EWEC3790100 | 42 € | 671-EWEC60100 | 46 € | EW450100 | 4 € | EW5350100 | 8 € |
| 130 | 671-EWEC9720130 | 16 € | 671-EWEC3790130 | 46 € | 671-EWEC60130 | 51 € | EW450130 | 4 € | - | - |
| 150 | 671-EWEC9720150 | 18 € | 671-EWEC3790150 | 56 € | 671-EWEC60150 | 64 € | EW450150 | 5 € | - | - |
| 180 | 671-EWEC9720180 | 23 € | 671-EWEC3790180 | 69 € | 671-EWEC60180 | 76 € | EW450180 | 6 € | - | - |
| 200 | 671-EWEC9720200 | 24 € | 671-EWEC3790200 | 77 € | 671-EWEC60200 | 87 € | EW450200 | 7 € | - | - |
| 250 | 671-EWEC9720250 | 27 € | 671-EWEC3790250 | 96 € | 671-EWEC60250 | 107 € | EW450250 | 11 € | - | - |
| 300 | 671-EWEC9720300 | 30 € | 671-EWEC3790300 | 115 € | 671-EWEC60300 | 129 € | EW450300 | 14 € | - | - |
| 350 | 671-EWEC9720350 | 37 € | 671-EWEC3790350 | 125 € | 671-EWEC60350 | 141 € | EW450350 | 16 € | - | - |
| 400 | 671-EWEC9720400 | 49 € | 671-EWEC3790400 | 138 € | 671-EWEC60400 | 154 € | EW450400 | 21 € | - | - |
| 450 | 671-EWEC9720450 | 57 € | 671-EWEC3790450 | 203 € | 671-EWEC60450 | 227 € | EW450450 | 24 € | - | - |
| 500 | 671-EWEC9720500 | 71 € | 671-EWEC3790500 | 286 € | 671-EWEC60500 | 319 € | EW450500 | 26 € | - | - |
| 550 | 671-EWEC9720550 | 115 € | 671-EWEC3790550 | 416 € | 671-EWEC60550 | 466 € | EW450550 | 28 € | - | - |
| 600 | 671-EWEC9720600 | 132 € | 671-EWEC3790600 | 450 € | 671-EWEC60600 | 504 € | EW450600 | 33 € | - | - |
| 650 | 671-EWEC9720650 | 137 € | 671-EWEC3790650 | 475 € | 671-EWEC60650 | 532 € | EW450650 | 36 € | - | - |
| 700 | 671-EWEC9720700 | 171 € | 671-EWEC3790700 | 590 € | 671-EWEC60700 | 663 € | EW450700 | 43 € | - | - |
| 750 | 671-EWEC9720750 | 178 € | 671-EWEC3790750 | 617 € | 671-EWEC60750 | 692 € | EW450750 | 52 € | - | - |
| 800 | 671-EWEC9720800 | 193 € | 671-EWEC3790800 | 672 € | 671-EWEC60800 | 754 € | EW450800 | 59 € | - | - |



Abrazadera fijación pared regulable 50-80 mm



Abrazadera fijación pared fija



Abrazadera de amarre por tornillo



Base de abrazadera distanciadora*



Alas distanciadoras A*

| Ø | CÓDIGO | € | CÓDIGO | € | CÓDIGO | € | CÓDIGO | € | CÓDIGO | € |
|-----|-----------|------|------------|-------|------------|-------|------------|-------|---------------|------|
| 80 | EW5560080 | 17 € | - | - | EW10630080 | 14 € | EW14620080 | 22 € | 665-ZUWA1462A | 26 € |
| 100 | EW5560100 | 19 € | - | - | EW10630100 | 16 € | EW14620100 | 23 € | | |
| 130 | EW5560130 | 21 € | - | - | EW10630130 | 18 € | EW14620130 | 25 € | | |
| 150 | EW5560150 | 22 € | - | - | EW10630150 | 20 € | EW14620150 | 27 € | | |
| 180 | EW5560180 | 22 € | - | - | EW10630180 | 22 € | EW14620180 | 29 € | | |
| 200 | EW5560200 | 25 € | - | - | EW10630200 | 24 € | EW14620200 | 32 € | | |
| 250 | EW5560250 | 34 € | - | - | EW10630250 | 28 € | EW14620250 | 57 € | | |
| 300 | EW5560300 | 36 € | - | - | EW10630300 | 37 € | EW14620300 | 77 € | | |
| 350 | EW5560350 | 39 € | - | - | EW10630350 | 42 € | EW14620350 | 105 € | | |
| 400 | EW5560400 | 49 € | - | - | EW10630400 | 48 € | EW14620400 | 137 € | | |
| 450 | EW5560450 | 55 € | - | - | EW10630450 | 54 € | EW14620450 | 170 € | | |
| 500 | - | - | EW556F0500 | 71 € | EW10630500 | 60 € | EW14620500 | 186 € | | |
| 550 | - | - | EW556F0550 | 88 € | EW10630550 | 66 € | EW14620550 | 208 € | | |
| 600 | - | - | EW556F0600 | 105 € | EW10630600 | 72 € | EW14620600 | 235 € | | |
| 650 | - | - | EW556F0650 | 115 € | EW10630650 | 78 € | EW14620650 | 253 € | | |
| 700 | - | - | EW556F0700 | 149 € | EW10630700 | 86 € | EW14620700 | 327 € | | |
| 750 | - | - | EW556F0750 | 183 € | EW10630750 | 95 € | EW14620750 | 334 € | | |
| 800 | - | - | EW556F0800 | 204 € | EW10630800 | 101 € | EW14620800 | 448 € | | |

* Consultar página 177 para ver



93 699 46 04



pedidos@suministrosrado.com www.suministrosrado.com



Alas distanciadoras B*



Alas distanciadoras C*



Alas distanciadoras D*



Abrazadera de araña



Abrazadera forjado inox

| Ø | CÓDIGO | € | CÓDIGO | € | CÓDIGO | € | CÓDIGO | € | CÓDIGO | € |
|-----|---------------|-------|---------------|------|---------------|------|----------|------|----------|------|
| 80 | 665-ZUWA1462B | 37 € | 665-ZUWA1462C | 46 € | 665-ZUWA1462D | 59 € | EW400080 | 6 € | EW620080 | 9 € |
| 100 | | | | | | | EW400100 | 6 € | EW620100 | 11 € |
| 130 | | | | | | | EW400130 | 6 € | EW620130 | 14 € |
| 150 | | | | | | | EW400150 | 6 € | EW620150 | 17 € |
| 180 | | | | | | | EW400180 | 8 € | EW620180 | 24 € |
| 200 | | | | | | | EW400200 | 8 € | EW620200 | 26 € |
| 250 | | | | | | | EW400250 | 14 € | EW620250 | 28 € |
| 300 | | | | | | | EW400300 | 16 € | EW620300 | 33 € |
| 350 | | | | | | | EW400350 | 19 € | EW620350 | 38 € |
| 400 | | | | | | | EW400400 | 21 € | EW620400 | 42 € |
| 450 | | | | | | | EW400450 | 23 € | - | - |
| 500 | | | | | | | EW400500 | 31 € | - | - |
| 550 | | | | | | | EW400550 | 42 € | - | - |
| 600 | | | | | | | EW400600 | 55 € | - | - |
| 650 | | | | | | | EW400650 | 60 € | - | - |
| 700 | | | | | | | EW400700 | 77 € | - | - |
| 750 | EW400750 | 94 € | - | - | | | | | | |
| 800 | EW400800 | 106 € | - | - | | | | | | |

* Consultar página 177 para ver distancias de separación



Abrazadera de soporte



Abrazadera de descenso



Soporte de techo



Abrazadera con doble pértiga telescópica



Abrazadera vientos

| Ø | CÓDIGO | € | CÓDIGO | € | CÓDIGO | € | CÓDIGO | € | CÓDIGO | € |
|-----|-----------|-------|-----------|-------|-----------|-------|-----------|-------|----------|-------|
| 80 | - | - | EW40D0080 | 8 € | EW9360080 | 16 € | - | - | EW420080 | 6 € |
| 100 | - | - | EW40D0100 | 8 € | EW9360100 | 18 € | - | - | EW420100 | 6 € |
| 130 | - | - | EW40D0130 | 8 € | EW9360130 | 19 € | EW1910130 | 82 € | EW420130 | 7 € |
| 150 | - | - | EW40D0150 | 10 € | EW9360150 | 23 € | EW1910150 | 84 € | EW420150 | 8 € |
| 180 | EW8580180 | 83 € | EW40D0180 | 13 € | EW9360180 | 28 € | EW1910180 | 89 € | EW420180 | 11 € |
| 200 | EW8580200 | 83 € | EW40D0200 | 15 € | EW9360200 | 31 € | EW1910200 | 98 € | EW420200 | 14 € |
| 250 | EW8580250 | 105 € | EW40D0250 | 23 € | EW9360250 | 41 € | EW1910250 | 111 € | EW420250 | 16 € |
| 300 | EW8580300 | 115 € | EW40D0300 | 27 € | EW9360300 | 48 € | EW1910300 | 132 € | EW420300 | 19 € |
| 350 | EW8580350 | 126 € | EW40D0350 | 31 € | EW9360350 | 52 € | EW1910350 | 142 € | EW420350 | 21 € |
| 400 | EW8580400 | 154 € | EW40D0400 | 42 € | EW9360400 | 59 € | EW1910400 | 156 € | EW420400 | 23 € |
| 450 | EW8580450 | 183 € | EW40D0450 | 48 € | EW9360450 | 82 € | EW1910450 | 217 € | EW420450 | 31 € |
| 500 | EW8580500 | 201 € | EW40D0500 | 52 € | EW9360500 | 106 € | EW1910500 | 282 € | EW420500 | 42 € |
| 550 | EW8580550 | 229 € | EW40D0550 | 56 € | EW9360550 | 137 € | EW1910550 | 368 € | EW420550 | 55 € |
| 600 | EW8580600 | 259 € | EW40D0600 | 67 € | EW9360600 | 149 € | EW1910600 | 399 € | EW420600 | 60 € |
| 650 | EW8580650 | 280 € | EW40D0650 | 71 € | EW9360650 | 162 € | EW1910650 | 437 € | EW420650 | 66 € |
| 700 | EW8580700 | 363 € | EW40D0700 | 86 € | EW9360700 | 187 € | EW1910700 | 498 € | EW420700 | 86 € |
| 750 | EW8580750 | 444 € | EW40D0750 | 105 € | EW9360750 | 210 € | EW1910750 | 557 € | EW420750 | 105 € |
| 800 | EW8580800 | 497 € | EW40D0800 | 117 € | EW9360800 | 241 € | EW1910800 | 643 € | EW420800 | 116 € |



93 699 46 04



pedidos@suministrosrado.com www.suministrosrado.com



Sistema EW - ECO 316



Pasamuros



Cubreaguas plano inox



Cubreaguas plomo
0° - 5°



Cubreaguas plomo
5° - 25°

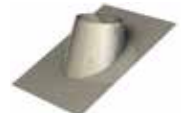

Cubreaguas plomo
25° - 45°

| Ø | CÓDIGO | € | CÓDIGO | € | CÓDIGO | € | CÓDIGO | € | CÓDIGO | € |
|-----|-----------|-------|------------|-------|-----------|-------|-----------|-------|-----------|-------|
| 80 | EW9870080 | 17 € | EW11280080 | 115 € | EW9370080 | 115 € | EW9380080 | 115 € | EW9390080 | 198 € |
| 100 | EW9870100 | 21 € | EW11280100 | 116 € | EW9370100 | 116 € | EW9380100 | 116 € | EW9390100 | 202 € |
| 130 | EW9870130 | 22 € | EW11280130 | 117 € | EW9370130 | 117 € | EW9380130 | 117 € | EW9390130 | 204 € |
| 150 | EW9870150 | 23 € | EW11280150 | 118 € | EW9370150 | 118 € | EW9380150 | 118 € | EW9390150 | 206 € |
| 180 | EW9870180 | 29 € | EW11280180 | 133 € | EW9370180 | 133 € | EW9380180 | 133 € | EW9390180 | 216 € |
| 200 | EW9870200 | 29 € | EW11280200 | 147 € | EW9370200 | 147 € | EW9380200 | 147 € | EW9390200 | 219 € |
| 250 | EW9870250 | 37 € | EW11280250 | 167 € | EW9370250 | 167 € | EW9380250 | 167 € | EW9390250 | 229 € |
| 300 | EW9870300 | 47 € | EW11280300 | 185 € | EW9370300 | 185 € | EW9380300 | 185 € | EW9390300 | 239 € |
| 350 | EW9870350 | 52 € | EW11280350 | 205 € | EW9370350 | 205 € | EW9380350 | 205 € | EW9390350 | 245 € |
| 400 | EW9870400 | 69 € | EW11280400 | 225 € | EW9370400 | 225 € | EW9380400 | 225 € | EW9390400 | 259 € |
| 450 | EW9870450 | 89 € | EW11280450 | 243 € | EW9370450 | 243 € | EW9380450 | 243 € | EW9390450 | 309 € |
| 500 | EW9870500 | 116 € | EW11280500 | 278 € | EW9370500 | 278 € | EW9380500 | 278 € | EW9390500 | 353 € |
| 550 | EW9870550 | 126 € | EW11280550 | 307 € | EW9370550 | 307 € | EW9380550 | 307 € | EW9390550 | 394 € |
| 600 | EW9870600 | 139 € | EW11280600 | 346 € | EW9370600 | 346 € | EW9380600 | 346 € | EW9390600 | 442 € |
| 650 | EW9870650 | 155 € | EW11280650 | 389 € | EW9370650 | 389 € | EW9380650 | 389 € | EW9390650 | 496 € |
| 700 | EW9870700 | 193 € | EW11280700 | 436 € | EW9370700 | 436 € | EW9380700 | 436 € | EW9390700 | 556 € |
| 750 | EW9870750 | 227 € | EW11280750 | 464 € | EW9370750 | 464 € | EW9380750 | 464 € | EW9390750 | 591 € |
| 800 | EW9870800 | 266 € | EW11280800 | 485 € | EW9370800 | 485 € | EW9380800 | 485 € | EW9390800 | 617 € |



Cubreaguas
5° - 25° aluminio

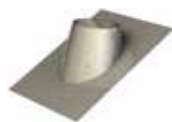

Cubreaguas
25° - 45° aluminio



Collarín antitormenta



Junta de estanqueidad
(T<200°C)

| Ø | CÓDIGO | € | CÓDIGO | € | CÓDIGO | € | CÓDIGO | € |
|-----|-------------|-------|-------------|-------|-----------|-------|----------|------|
| 80 | EW938AL0080 | 67 € | EW939AL0080 | 115 € | EW3070080 | 14 € | EW260080 | 3 € |
| 100 | EW938AL0100 | 69 € | EW939AL0100 | 119 € | EW3070100 | 15 € | EW260100 | 3 € |
| 130 | EW938AL0130 | 79 € | EW939AL0130 | 137 € | EW3070130 | 16 € | EW260130 | 3 € |
| 150 | EW938AL0150 | 85 € | EW939AL0150 | 138 € | EW3070150 | 19 € | EW260150 | 3 € |
| 180 | EW938AL0180 | 93 € | EW939AL0180 | 144 € | EW3070180 | 23 € | EW260180 | 4 € |
| 200 | EW938AL0200 | 102 € | EW939AL0200 | 146 € | EW3070200 | 26 € | EW260200 | 5 € |
| 250 | EW938AL0250 | 111 € | EW939AL0250 | 154 € | EW3070250 | 33 € | EW260250 | 7 € |
| 300 | EW938AL0300 | 134 € | EW939AL0300 | 186 € | EW3070300 | 40 € | EW260300 | 8 € |
| 350 | EW938AL0350 | 141 € | EW939AL0350 | 195 € | EW3070350 | 43 € | EW260350 | 9 € |
| 400 | EW938AL0400 | 170 € | EW939AL0400 | 236 € | EW3070400 | 47 € | EW260400 | 10 € |
| 450 | EW938AL0450 | 186 € | EW939AL0450 | 258 € | EW3070450 | 66 € | EW260450 | 11 € |
| 500 | EW938AL0500 | 254 € | EW939AL0500 | 352 € | EW3070500 | 86 € | EW260500 | 13 € |
| 550 | EW938AL0550 | 286 € | EW939AL0550 | 397 € | EW3070550 | 112 € | EW260550 | 15 € |
| 600 | EW938AL0600 | 304 € | EW939AL0600 | 422 € | EW3070600 | 121 € | EW260600 | 17 € |
| 650 | EW938AL0650 | 378 € | EW939AL0650 | 525 € | EW3070650 | 133 € | EW260650 | 20 € |
| 700 | EW938AL0700 | 455 € | EW939AL0700 | 630 € | EW3070700 | 152 € | EW260700 | 23 € |
| 750 | EW938AL0750 | 467 € | EW939AL0750 | 648 € | EW3070750 | 169 € | EW260750 | 25 € |
| 800 | EW938AL0800 | 543 € | EW939AL0800 | 753 € | EW3070800 | 195 € | EW260800 | 27 € |



93 699 46 04



pedidos@suministrosrado.com www.suministrosrado.com

ADAPTADOR CALDERA HEMBRA

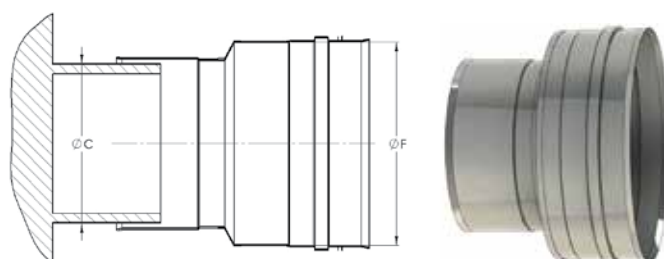

| CÓDIGO | ØC CALDERA | ØF CHIMENEA | € |
|---------------------|------------|-------------|------|
| 671-EWEC37H00800080 | 78 a 82 | 80 | 15 € |
| 671-EWEC37H00800100 | 78 a 82 | 100 | 37 € |
| 671-EWEC37H00800130 | 78 a 82 | 130 | 38 € |
| 671-EWEC37H01000080 | 98 a 102 | 80 | 38 € |
| 671-EWEC37H01000100 | 98 a 102 | 100 | 16 € |
| 671-EWEC37H01000130 | 98 a 102 | 130 | 39 € |
| 671-EWEC37H01000150 | 98 a 102 | 150 | 45 € |
| 671-EWEC37H01100080 | 108 a 112 | 80 | 38 € |
| 671-EWEC37H01100100 | 108 a 112 | 100 | 39 € |
| 671-EWEC37H01100130 | 108 a 112 | 130 | 39 € |
| 671-EWEC37H01100150 | 108 a 112 | 150 | 45 € |
| 671-EWEC37H01200080 | 118 a 122 | 80 | 39 € |
| 671-EWEC37H01200100 | 118 a 122 | 100 | 39 € |
| 671-EWEC37H01200130 | 118 a 122 | 130 | 39 € |
| 671-EWEC37H01200150 | 118 a 122 | 150 | 45 € |
| 671-EWEC37H01250080 | 123 a 127 | 80 | 39 € |
| 671-EWEC37H01250100 | 123 a 127 | 100 | 39 € |
| 671-EWEC37H01250130 | 123 a 127 | 130 | 18 € |
| 671-EWEC37H01250150 | 123 a 127 | 150 | 45 € |
| 671-EWEC37H01300080 | 128 a 132 | 80 | 39 € |
| 671-EWEC37H01300100 | 128 a 132 | 100 | 39 € |
| 671-EWEC37H01300130 | 128 a 132 | 130 | 18 € |
| 671-EWEC37H01300150 | 128 a 132 | 150 | 46 € |
| 671-EWEC37H01300180 | 128 a 132 | 180 | 54 € |
| 671-EWEC37H01350080 | 133 a 137 | 80 | 36 € |
| 671-EWEC37H01350100 | 133 a 137 | 100 | 47 € |
| 671-EWEC37H01350130 | 133 a 137 | 130 | 18 € |
| 671-EWEC37H01350150 | 133 a 137 | 150 | 46 € |
| 671-EWEC37H01350180 | 133 a 137 | 180 | 54 € |
| 671-EWEC37H01400080 | 138 a 142 | 80 | 59 € |
| 671-EWEC37H01400100 | 138 a 142 | 100 | 47 € |
| 671-EWEC37H01400130 | 138 a 142 | 130 | 48 € |
| 671-EWEC37H01400150 | 138 a 142 | 150 | 21 € |
| 671-EWEC37H01400180 | 138 a 142 | 180 | 54 € |
| 671-EWEC37H01500080 | 148 a 152 | 80 | 60 € |
| 671-EWEC37H01500100 | 148 a 152 | 100 | 47 € |
| 671-EWEC37H01500130 | 148 a 152 | 130 | 48 € |
| 671-EWEC37H01500150 | 148 a 152 | 150 | 21 € |
| 671-EWEC37H01500180 | 148 a 152 | 180 | 54 € |
| 671-EWEC37H01500200 | 148 a 152 | 200 | 63 € |
| 671-EWEC37H01600080 | 158 a 162 | 80 | 98 € |
| 671-EWEC37H01600100 | 158 a 162 | 100 | 56 € |
| 671-EWEC37H01600130 | 158 a 162 | 130 | 57 € |
| 671-EWEC37H01600150 | 158 a 162 | 150 | 21 € |
| 671-EWEC37H01600180 | 158 a 162 | 180 | 54 € |
| 671-EWEC37H01600200 | 158 a 162 | 200 | 63 € |
| 671-EWEC37H01750080 | 173 a 177 | 80 | 98 € |
| 671-EWEC37H01750100 | 173 a 177 | 100 | 56 € |
| 671-EWEC37H01750130 | 173 a 177 | 130 | 57 € |
| 671-EWEC37H01750150 | 173 a 177 | 150 | 55 € |
| 671-EWEC37H01750180 | 173 a 177 | 180 | 25 € |
| 671-EWEC37H01750200 | 173 a 177 | 200 | 63 € |
| 671-EWEC37H01800080 | 178 a 182 | 80 | 98 € |
| 671-EWEC37H01800100 | 178 a 182 | 100 | 56 € |
| 671-EWEC37H01800130 | 178 a 182 | 130 | 57 € |
| 671-EWEC37H01800150 | 178 a 182 | 150 | 55 € |
| 671-EWEC37H01800180 | 178 a 182 | 180 | 25 € |
| 671-EWEC37H01800200 | 178 a 182 | 200 | 64 € |
| 671-EWEC37H01800250 | 178 a 182 | 250 | 69 € |

| CÓDIGO | ØC CALDERA | ØF CHIMENEA | € |
|---------------------|------------|-------------|-------|
| 671-EWEC37H02000150 | 198 a 202 | 150 | 64 € |
| 671-EWEC37H02000180 | 198 a 202 | 180 | 64 € |
| 671-EWEC37H02000200 | 198 a 202 | 200 | 29 € |
| 671-EWEC37H02000250 | 198 a 202 | 250 | 70 € |
| 671-EWEC37H02000300 | 198 a 202 | 300 | 93 € |
| 671-EWEC37H02250180 | 223 a 227 | 180 | 67 € |
| 671-EWEC37H02250200 | 223 a 227 | 200 | 68 € |
| 671-EWEC37H02250250 | 223 a 227 | 250 | 70 € |
| 671-EWEC37H02250300 | 223 a 227 | 300 | 93 € |
| 671-EWEC37H02500180 | 248 a 252 | 180 | 67 € |
| 671-EWEC37H02500200 | 248 a 252 | 200 | 68 € |
| 671-EWEC37H02500250 | 248 a 252 | 250 | 37 € |
| 671-EWEC37H02500300 | 248 a 252 | 300 | 95 € |
| 671-EWEC37H02500350 | 248 a 252 | 350 | 94 € |
| 671-EWEC37H03000200 | 298 a 302 | 200 | 89 € |
| 671-EWEC37H03000250 | 298 a 302 | 250 | 93 € |
| 671-EWEC37H03000300 | 298 a 302 | 300 | 44 € |
| 671-EWEC37H03000350 | 298 a 302 | 350 | 96 € |
| 671-EWEC37H03000400 | 298 a 302 | 400 | 109 € |
| 671-EWEC37H03500250 | 348 a 352 | 250 | 108 € |
| 671-EWEC37H03500300 | 348 a 352 | 300 | 112 € |
| 671-EWEC37H03500350 | 348 a 352 | 350 | 48 € |
| 671-EWEC37H03500400 | 348 a 352 | 400 | 114 € |
| 671-EWEC37H03500450 | 348 a 352 | 450 | 180 € |
| 671-EWEC37H04000300 | 398 a 402 | 300 | 125 € |
| 671-EWEC37H04000350 | 398 a 402 | 350 | 113 € |
| 671-EWEC37H04000400 | 398 a 402 | 400 | 52 € |
| 671-EWEC37H04000450 | 398 a 402 | 450 | 182 € |
| 671-EWEC37H04000500 | 398 a 402 | 500 | 243 € |
| 671-EWEC37H04500350 | 448 a 452 | 350 | 152 € |
| 671-EWEC37H04500400 | 448 a 452 | 400 | 156 € |
| 671-EWEC37H04500450 | 448 a 452 | 450 | 73 € |
| 671-EWEC37H04500500 | 448 a 452 | 500 | 249 € |
| 671-EWEC37H04500550 | 448 a 452 | 550 | 444 € |
| 671-EWEC37H05000400 | 498 a 502 | 400 | 158 € |
| 671-EWEC37H05000450 | 498 a 502 | 450 | 189 € |
| 671-EWEC37H05000500 | 498 a 502 | 500 | 103 € |
| 671-EWEC37H05000550 | 498 a 502 | 550 | 449 € |
| 671-EWEC37H05000600 | 498 a 502 | 600 | 468 € |
| 671-EWEC37H05500450 | 548 a 552 | 450 | 272 € |
| 671-EWEC37H05500500 | 548 a 552 | 500 | 362 € |
| 671-EWEC37H05500550 | 548 a 552 | 550 | 145 € |
| 671-EWEC37H05500600 | 548 a 552 | 600 | 473 € |
| 671-EWEC37H05500650 | 548 a 552 | 650 | 507 € |
| 671-EWEC37H06000500 | 598 a 602 | 500 | 376 € |
| 671-EWEC37H06000550 | 598 a 602 | 550 | 472 € |
| 671-EWEC37H06000600 | 598 a 602 | 600 | 170 € |
| 671-EWEC37H06000650 | 598 a 602 | 650 | 513 € |
| 671-EWEC37H06000700 | 598 a 602 | 700 | 545 € |
| 671-EWEC37H06500650 | 648 a 652 | 650 | 185 € |
| 671-EWEC37H06500700 | 648 a 652 | 700 | 553 € |
| 671-EWEC37H06500750 | 648 a 652 | 750 | 584 € |
| 671-EWEC37H07000700 | 698 a 702 | 700 | 200 € |
| 671-EWEC37H07000750 | 698 a 702 | 750 | 593 € |
| 671-EWEC37H07000800 | 698 a 702 | 800 | 623 € |
| 671-EWEC37H07500750 | 748 a 752 | 750 | 214 € |
| 671-EWEC37H07500800 | 748 a 752 | 800 | 632 € |
| 671-EWEC37H08000800 | 798 a 802 | 800 | 229 € |





Sistema EW - ECO 316

ADAPTADOR CALDERA MACHO

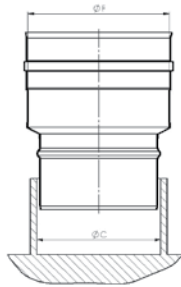

| CÓDIGO | ØC CALDERA | ØF CHIMENEA | € |
|---------------------|------------|-------------|------|
| 671-EWEC37M00800080 | 78 a 82 | 80 | 15 € |
| 671-EWEC37M00800100 | 78 a 82 | 100 | 37 € |
| 671-EWEC37M00800130 | 78 a 82 | 130 | 38 € |
| 671-EWEC37M01000080 | 98 a 102 | 80 | 38 € |
| 671-EWEC37M01000100 | 98 a 102 | 100 | 16 € |
| 671-EWEC37M01000130 | 98 a 102 | 130 | 39 € |
| 671-EWEC37M01000150 | 98 a 102 | 150 | 45 € |
| 671-EWEC37M01100080 | 108 a 112 | 80 | 38 € |
| 671-EWEC37M01100100 | 108 a 112 | 100 | 39 € |
| 671-EWEC37M01100130 | 108 a 112 | 130 | 39 € |
| 671-EWEC37M01100150 | 108 a 112 | 150 | 45 € |
| 671-EWEC37M01200080 | 118 a 122 | 80 | 39 € |
| 671-EWEC37M01200100 | 118 a 122 | 100 | 39 € |
| 671-EWEC37M01200130 | 118 a 122 | 130 | 39 € |
| 671-EWEC37M01200150 | 118 a 122 | 150 | 45 € |
| 671-EWEC37M01250080 | 123 a 127 | 80 | 39 € |
| 671-EWEC37M01250100 | 123 a 127 | 100 | 39 € |
| 671-EWEC37M01250130 | 123 a 127 | 130 | 18 € |
| 671-EWEC37M01250150 | 123 a 127 | 150 | 45 € |
| 671-EWEC37M01300080 | 128 a 132 | 80 | 39 € |
| 671-EWEC37M01300100 | 128 a 132 | 100 | 39 € |
| 671-EWEC37M01300130 | 128 a 132 | 130 | 18 € |
| 671-EWEC37M01300150 | 128 a 132 | 150 | 46 € |
| 671-EWEC37M01300180 | 128 a 132 | 180 | 54 € |
| 671-EWEC37M01350080 | 133 a 137 | 80 | 36 € |
| 671-EWEC37M01350100 | 133 a 137 | 100 | 47 € |
| 671-EWEC37M01350130 | 133 a 137 | 130 | 18 € |
| 671-EWEC37M01350150 | 133 a 137 | 150 | 46 € |
| 671-EWEC37M01350180 | 133 a 137 | 180 | 54 € |
| 671-EWEC37M01400080 | 138 a 142 | 80 | 59 € |
| 671-EWEC37M01400100 | 138 a 142 | 100 | 47 € |
| 671-EWEC37M01400130 | 138 a 142 | 130 | 48 € |
| 671-EWEC37M01400150 | 138 a 142 | 150 | 21 € |
| 671-EWEC37M01400180 | 138 a 142 | 180 | 54 € |
| 671-EWEC37M01500080 | 148 a 152 | 80 | 60 € |
| 671-EWEC37M01500100 | 148 a 152 | 100 | 47 € |
| 671-EWEC37M01500130 | 148 a 152 | 130 | 48 € |
| 671-EWEC37M01500150 | 148 a 152 | 150 | 21 € |
| 671-EWEC37M01500180 | 148 a 152 | 180 | 54 € |
| 671-EWEC37M01500200 | 148 a 152 | 200 | 63 € |
| 671-EWEC37M01600080 | 158 a 162 | 80 | 98 € |
| 671-EWEC37M01600100 | 158 a 162 | 100 | 56 € |
| 671-EWEC37M01600130 | 158 a 162 | 130 | 57 € |
| 671-EWEC37M01600150 | 158 a 162 | 150 | 21 € |
| 671-EWEC37M01600180 | 158 a 162 | 180 | 54 € |
| 671-EWEC37M01600200 | 158 a 162 | 200 | 63 € |
| 671-EWEC37M01750080 | 173 a 177 | 80 | 98 € |
| 671-EWEC37M01750100 | 173 a 177 | 100 | 56 € |
| 671-EWEC37M01750130 | 173 a 177 | 130 | 57 € |
| 671-EWEC37M01750150 | 173 a 177 | 150 | 55 € |
| 671-EWEC37M01750180 | 173 a 177 | 180 | 25 € |
| 671-EWEC37M01750200 | 173 a 177 | 200 | 63 € |
| 671-EWEC37M01800080 | 178 a 182 | 80 | 98 € |
| 671-EWEC37M01800100 | 178 a 182 | 100 | 56 € |
| 671-EWEC37M01800130 | 178 a 182 | 130 | 57 € |
| 671-EWEC37M01800150 | 178 a 182 | 150 | 55 € |
| 671-EWEC37M01800180 | 178 a 182 | 180 | 25 € |
| 671-EWEC37M01800200 | 178 a 182 | 200 | 64 € |
| 671-EWEC37M01800250 | 178 a 182 | 250 | 69 € |

| CÓDIGO | ØC CALDERA | ØF CHIMENEA | € |
|---------------------|------------|-------------|-------|
| 671-EWEC37M02000150 | 198 a 202 | 150 | 64 € |
| 671-EWEC37M02000180 | 198 a 202 | 180 | 64 € |
| 671-EWEC37M02000200 | 198 a 202 | 200 | 29 € |
| 671-EWEC37M02000250 | 198 a 202 | 250 | 70 € |
| 671-EWEC37M02000300 | 198 a 202 | 300 | 93 € |
| 671-EWEC37M02250180 | 223 a 227 | 180 | 67 € |
| 671-EWEC37M02250200 | 223 a 227 | 200 | 68 € |
| 671-EWEC37M02250250 | 223 a 227 | 250 | 70 € |
| 671-EWEC37M02250300 | 223 a 227 | 300 | 93 € |
| 671-EWEC37M02500180 | 248 a 252 | 180 | 67 € |
| 671-EWEC37M02500200 | 248 a 252 | 200 | 68 € |
| 671-EWEC37M02500250 | 248 a 252 | 250 | 37 € |
| 671-EWEC37M02500300 | 248 a 252 | 300 | 95 € |
| 671-EWEC37M02500350 | 248 a 252 | 350 | 94 € |
| 671-EWEC37M03000200 | 298 a 302 | 200 | 89 € |
| 671-EWEC37M03000250 | 298 a 302 | 250 | 93 € |
| 671-EWEC37M03000300 | 298 a 302 | 300 | 44 € |
| 671-EWEC37M03000350 | 298 a 302 | 350 | 96 € |
| 671-EWEC37M03000400 | 298 a 302 | 400 | 109 € |
| 671-EWEC37M03500250 | 348 a 352 | 250 | 108 € |
| 671-EWEC37M03500300 | 348 a 352 | 300 | 112 € |
| 671-EWEC37M03500350 | 348 a 352 | 350 | 48 € |
| 671-EWEC37M03500400 | 348 a 352 | 400 | 114 € |
| 671-EWEC37M03500450 | 348 a 352 | 450 | 180 € |
| 671-EWEC37M04000300 | 398 a 402 | 300 | 125 € |
| 671-EWEC37M04000350 | 398 a 402 | 350 | 113 € |
| 671-EWEC37M04000400 | 398 a 402 | 400 | 52 € |
| 671-EWEC37M04000450 | 398 a 402 | 450 | 182 € |
| 671-EWEC37M04000500 | 398 a 402 | 500 | 243 € |
| 671-EWEC37M04500350 | 448 a 452 | 350 | 152 € |
| 671-EWEC37M04500400 | 448 a 452 | 400 | 156 € |
| 671-EWEC37M04500450 | 448 a 452 | 450 | 73 € |
| 671-EWEC37M04500500 | 448 a 452 | 500 | 249 € |
| 671-EWEC37M04500550 | 448 a 452 | 550 | 444 € |
| 671-EWEC37M05000400 | 498 a 502 | 400 | 158 € |
| 671-EWEC37M05000450 | 498 a 502 | 450 | 189 € |
| 671-EWEC37M05000500 | 498 a 502 | 500 | 103 € |
| 671-EWEC37M05000550 | 498 a 502 | 550 | 449 € |
| 671-EWEC37M05000600 | 498 a 502 | 600 | 468 € |
| 671-EWEC37M05500450 | 548 a 552 | 450 | 272 € |
| 671-EWEC37M05500500 | 548 a 552 | 500 | 362 € |
| 671-EWEC37M05500550 | 548 a 552 | 550 | 145 € |
| 671-EWEC37M05500600 | 548 a 552 | 600 | 473 € |
| 671-EWEC37M05500650 | 548 a 552 | 650 | 507 € |
| 671-EWEC37M06000500 | 598 a 602 | 500 | 376 € |
| 671-EWEC37M06000550 | 598 a 602 | 550 | 472 € |
| 671-EWEC37M06000600 | 598 a 602 | 600 | 170 € |
| 671-EWEC37M06000650 | 598 a 602 | 650 | 513 € |
| 671-EWEC37M06000700 | 598 a 602 | 700 | 545 € |
| 671-EWEC37M06500650 | 648 a 652 | 650 | 185 € |
| 671-EWEC37M06500700 | 648 a 652 | 700 | 553 € |
| 671-EWEC37M06500750 | 648 a 652 | 750 | 584 € |
| 671-EWEC37M07000700 | 698 a 702 | 700 | 200 € |
| 671-EWEC37M07000750 | 698 a 702 | 750 | 593 € |
| 671-EWEC37M07000800 | 698 a 702 | 800 | 623 € |
| 671-EWEC37M07500750 | 748 a 752 | 750 | 214 € |
| 671-EWEC37M07500800 | 748 a 752 | 800 | 632 € |
| 671-EWEC37M08000800 | 798 a 802 | 800 | 229 € |



93 699 46 04



pedidos@suministrosrado.com www.suministrosrado.com



*con junta de estanqueidad

AMPLIACIONES

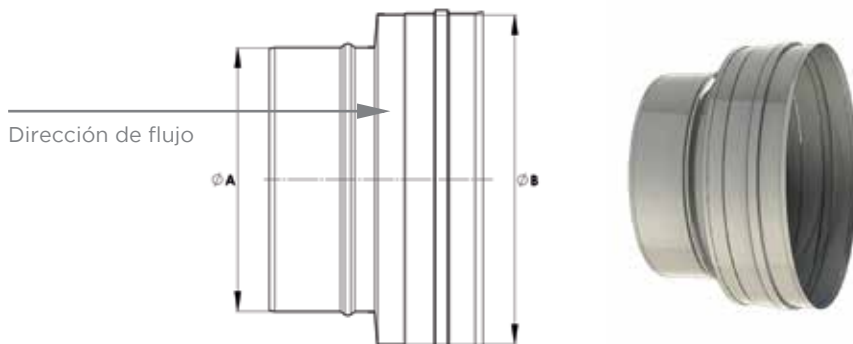

| CÓDIGO | Ø A | Ø B | € |
|-------------------|-----|-----|-------|
| 671-EWECA00800100 | 80 | 100 | 44 € |
| 671-EWECA00800130 | 80 | 130 | 54 € |
| 671-EWECA00800150 | 80 | 150 | 63 € |
| 671-EWECA00800180 | 80 | 180 | 73 € |
| 671-EWECA01000130 | 100 | 130 | 52 € |
| 671-EWECA01000150 | 100 | 150 | 61 € |
| 671-EWECA01000180 | 100 | 180 | 70 € |
| 671-EWECA01000200 | 100 | 200 | 94 € |
| 671-EWECA01300150 | 130 | 150 | 52 € |
| 671-EWECA01300180 | 130 | 180 | 65 € |
| 671-EWECA01300200 | 130 | 200 | 87 € |
| 671-EWECA01300250 | 130 | 250 | 107 € |
| 671-EWECA01300300 | 130 | 300 | 144 € |
| 671-EWECA01500180 | 150 | 180 | 59 € |
| 671-EWECA01500200 | 150 | 200 | 83 € |
| 671-EWECA01500250 | 150 | 250 | 102 € |
| 671-EWECA01500300 | 150 | 300 | 138 € |
| 671-EWECA01500350 | 150 | 350 | 162 € |
| 671-EWECA01800200 | 180 | 200 | 75 € |
| 671-EWECA01800250 | 180 | 250 | 98 € |
| 671-EWECA01800300 | 180 | 300 | 133 € |
| 671-EWECA01800350 | 180 | 350 | 156 € |
| 671-EWECA01800400 | 180 | 400 | 172 € |
| 671-EWECA02000250 | 200 | 250 | 89 € |
| 671-EWECA02000300 | 200 | 300 | 126 € |
| 671-EWECA02000350 | 200 | 350 | 149 € |
| 671-EWECA02000400 | 200 | 400 | 165 € |
| 671-EWECA02000450 | 200 | 450 | 187 € |
| 671-EWECA02500300 | 250 | 300 | 115 € |
| 671-EWECA02500350 | 250 | 350 | 142 € |
| 671-EWECA02500400 | 250 | 400 | 159 € |
| 671-EWECA02500450 | 250 | 450 | 180 € |
| 671-EWECA02500500 | 250 | 500 | 202 € |
| 671-EWECA03000350 | 300 | 350 | 130 € |
| 671-EWECA03000400 | 300 | 400 | 152 € |
| 671-EWECA03000450 | 300 | 450 | 171 € |
| 671-EWECA03000500 | 300 | 500 | 193 € |

| CÓDIGO | Ø A | Ø B | € |
|-------------------|-----|-----|-------|
| 671-EWECA03000550 | 300 | 550 | 209 € |
| 671-EWECA03500400 | 350 | 400 | 138 € |
| 671-EWECA03500450 | 350 | 450 | 164 € |
| 671-EWECA03500500 | 350 | 500 | 185 € |
| 671-EWECA03500550 | 350 | 550 | 201 € |
| 671-EWECA03500600 | 350 | 600 | 229 € |
| 671-EWECA04000450 | 400 | 450 | 149 € |
| 671-EWECA04000500 | 400 | 500 | 177 € |
| 671-EWECA04000550 | 400 | 550 | 192 € |
| 671-EWECA04000600 | 400 | 600 | 219 € |
| 671-EWECA04000650 | 400 | 650 | 243 € |
| 671-EWECA04500500 | 450 | 500 | 161 € |
| 671-EWECA04500550 | 450 | 550 | 184 € |
| 671-EWECA04500600 | 450 | 600 | 210 € |
| 671-EWECA04500650 | 450 | 650 | 233 € |
| 671-EWECA04500700 | 450 | 700 | 302 € |
| 671-EWECA05000550 | 500 | 550 | 167 € |
| 671-EWECA05000600 | 500 | 600 | 202 € |
| 671-EWECA05000650 | 500 | 650 | 224 € |
| 671-EWECA05000700 | 500 | 700 | 289 € |
| 671-EWECA05000750 | 500 | 750 | 317 € |
| 671-EWECA05500600 | 550 | 600 | 183 € |
| 671-EWECA05500650 | 550 | 650 | 214 € |
| 671-EWECA05500700 | 550 | 700 | 278 € |
| 671-EWECA05500750 | 550 | 750 | 303 € |
| 671-EWECA05500800 | 550 | 800 | 345 € |
| 671-EWECA06000650 | 600 | 650 | 194 € |
| 671-EWECA06000700 | 600 | 700 | 265 € |
| 671-EWECA06000750 | 600 | 750 | 291 € |
| 671-EWECA06000800 | 600 | 800 | 331 € |
| 671-EWECA06500700 | 650 | 700 | 241 € |
| 671-EWECA06500750 | 650 | 750 | 278 € |
| 671-EWECA06500800 | 650 | 800 | 318 € |
| 671-EWECA07000750 | 700 | 750 | 253 € |
| 671-EWECA07000800 | 700 | 800 | 303 € |
| 671-EWECA07500800 | 750 | 800 | 276 € |





Sistema EW - ECO 316

REDUCCIONES

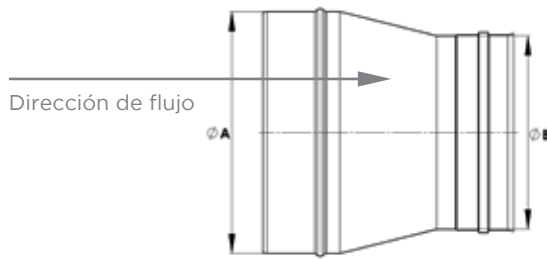

| CÓDIGO | Ø A | Ø B | € |
|-------------------|-----|-----|-------|
| 671-EWECR01000080 | 100 | 80 | 44 € |
| 671-EWECR01300080 | 130 | 80 | 54 € |
| 671-EWECR01300100 | 130 | 100 | 52 € |
| 671-EWECR01500080 | 150 | 80 | 63 € |
| 671-EWECR01500100 | 150 | 100 | 61 € |
| 671-EWECR01500130 | 150 | 130 | 52 € |
| 671-EWECR01800080 | 180 | 80 | 73 € |
| 671-EWECR01800100 | 180 | 100 | 70 € |
| 671-EWECR01800130 | 180 | 130 | 65 € |
| 671-EWECR01800150 | 180 | 150 | 59 € |
| 671-EWECR02000100 | 200 | 100 | 94 € |
| 671-EWECR02000130 | 200 | 130 | 87 € |
| 671-EWECR02000150 | 200 | 150 | 83 € |
| 671-EWECR02000180 | 200 | 180 | 75 € |
| 671-EWECR02500130 | 250 | 130 | 107 € |
| 671-EWECR02500150 | 250 | 150 | 102 € |
| 671-EWECR02500180 | 250 | 180 | 98 € |
| 671-EWECR02500200 | 250 | 200 | 89 € |
| 671-EWECR03000130 | 300 | 130 | 144 € |
| 671-EWECR03000150 | 300 | 150 | 138 € |
| 671-EWECR03000180 | 300 | 180 | 133 € |
| 671-EWECR03000200 | 300 | 200 | 126 € |
| 671-EWECR03000250 | 300 | 250 | 115 € |
| 671-EWECR03500150 | 350 | 150 | 162 € |
| 671-EWECR03500180 | 350 | 180 | 156 € |
| 671-EWECR03500200 | 350 | 200 | 149 € |
| 671-EWECR03500250 | 350 | 250 | 142 € |
| 671-EWECR03500300 | 350 | 300 | 130 € |
| 671-EWECR04000180 | 400 | 180 | 172 € |
| 671-EWECR04000200 | 400 | 200 | 165 € |
| 671-EWECR04000250 | 400 | 250 | 159 € |
| 671-EWECR04000300 | 400 | 300 | 152 € |
| 671-EWECR04000350 | 400 | 350 | 138 € |
| 671-EWECR04500200 | 450 | 200 | 187 € |
| 671-EWECR04500250 | 450 | 250 | 180 € |
| 671-EWECR04500300 | 450 | 300 | 171 € |
| 671-EWECR04500350 | 450 | 350 | 164 € |

| CÓDIGO | Ø A | Ø B | € |
|-------------------|-----|-----|-------|
| 671-EWECR04500400 | 450 | 400 | 149 € |
| 671-EWECR05000250 | 500 | 250 | 202 € |
| 671-EWECR05000300 | 500 | 300 | 193 € |
| 671-EWECR05000350 | 500 | 350 | 185 € |
| 671-EWECR05000400 | 500 | 400 | 177 € |
| 671-EWECR05000450 | 500 | 450 | 161 € |
| 671-EWECR05500300 | 550 | 300 | 209 € |
| 671-EWECR05500350 | 550 | 350 | 201 € |
| 671-EWECR05500400 | 550 | 400 | 192 € |
| 671-EWECR05500450 | 550 | 450 | 184 € |
| 671-EWECR05500500 | 550 | 500 | 167 € |
| 671-EWECR06000350 | 600 | 350 | 229 € |
| 671-EWECR06000400 | 600 | 400 | 219 € |
| 671-EWECR06000450 | 600 | 450 | 210 € |
| 671-EWECR06000500 | 600 | 500 | 202 € |
| 671-EWECR06000550 | 600 | 550 | 183 € |
| 671-EWECR06500400 | 650 | 400 | 243 € |
| 671-EWECR06500450 | 650 | 450 | 233 € |
| 671-EWECR06500500 | 650 | 500 | 224 € |
| 671-EWECR06500550 | 650 | 550 | 214 € |
| 671-EWECR06500600 | 650 | 600 | 194 € |
| 671-EWECR07000450 | 700 | 450 | 302 € |
| 671-EWECR07000500 | 700 | 500 | 289 € |
| 671-EWECR07000550 | 700 | 550 | 278 € |
| 671-EWECR07000600 | 700 | 600 | 265 € |
| 671-EWECR07000650 | 700 | 650 | 241 € |
| 671-EWECR07500500 | 750 | 500 | 317 € |
| 671-EWECR07500550 | 750 | 550 | 303 € |
| 671-EWECR07500600 | 750 | 600 | 291 € |
| 671-EWECR07500650 | 750 | 650 | 278 € |
| 671-EWECR07500700 | 750 | 700 | 253 € |
| 671-EWECR08000550 | 800 | 550 | 345 € |
| 671-EWECR08000600 | 800 | 600 | 331 € |
| 671-EWECR08000650 | 800 | 650 | 318 € |
| 671-EWECR08000700 | 800 | 700 | 303 € |
| 671-EWECR08000750 | 800 | 750 | 276 € |





Sistema EW - ECO 304

DESCRIPCIÓN

Chimenea modular metálica para evacuación de humos y gases de los productos de la combustión de simple pared fabricada en acero inoxidable

MATERIAL

AISI 304

ACABADO EXTERIOR

Brillante

Colores RAL sólo hasta 200°C (según diámetro, consultar precios)

ESPESORES (mm)

0,4 - 0,5 - 0,6 (según el diámetro)

DIÁMETROS DISPONIBLES (mm)

80 - 100 - 130 - 150 - 180 - 200 - 250 - 300 - 350 - 400 - 450 - 500 - 550 - 600 - 650 - 700 - 750 - 800

SISTEMA DE UNIÓN

Conexión macho-hembra con **abrazadera de unión sencilla**



APLICACIONES

- Calderas de gas y gasoil
- No condensación

CARACTERÍSTICAS

- Instalación por patinillo interior
- Temperatura de trabajo hasta 600°C
- **Soldadura TIG/LÁSER** en continuo en todas las piezas
- Abrazadera de unión **NO INCLUIDA**
- Posibilidad de **corte de módulos rectos a medida** en obra

CERTIFICADO CE

0036 CPD 9174 029

CLASIFICACIONES CE (UNE-EN 1856-1)

T600 - N1 - D - Vm - L20040 - G(100)

T400 - N1 - W - Vm - L20040 - O(50)

T200 - P1 - W - Vm - L20040 - O(00)



93 699 46 04



pedidos@suministrosrado.com www.suministrosrado.com



Sistema EW - ECO 304



Módulo recto 1.000 mm



Módulo recto 500 mm



Módulo recto 250 mm



Módulo recto regulable
400 - 560 mm



Módulo recto regulable
560 - 920 mm

| Ø | CÓDIGO | € | CÓDIGO | € | CÓDIGO | € | CÓDIGO | € | CÓDIGO | € |
|-----|----------------|-------|----------------|-------|----------------|-------|-----------------|-------|-----------------|-------|
| 80 | 670-EWEC130080 | 23 € | 670-EWEC140080 | 15 € | 670-EWEC150080 | 9 € | 670-EWEC5440080 | 29 € | 670-EWEC5450080 | 38 € |
| 100 | 670-EWEC130100 | 25 € | 670-EWEC140100 | 16 € | 670-EWEC150100 | 10 € | 670-EWEC5440100 | 33 € | 670-EWEC5450100 | 41 € |
| 130 | 670-EWEC130130 | 27 € | 670-EWEC140130 | 17 € | 670-EWEC150130 | 10 € | 670-EWEC5440130 | 38 € | 670-EWEC5450130 | 45 € |
| 150 | 670-EWEC130150 | 31 € | 670-EWEC140150 | 18 € | 670-EWEC150150 | 10 € | 670-EWEC5440150 | 46 € | 670-EWEC5450150 | 55 € |
| 180 | 670-EWEC130180 | 37 € | 670-EWEC140180 | 21 € | 670-EWEC150180 | 13 € | 670-EWEC5440180 | 55 € | 670-EWEC5450180 | 61 € |
| 200 | 670-EWEC130200 | 44 € | 670-EWEC140200 | 25 € | 670-EWEC150200 | 15 € | 670-EWEC5440200 | 57 € | 670-EWEC5450200 | 68 € |
| 250 | 670-EWEC130250 | 59 € | 670-EWEC140250 | 31 € | 670-EWEC150250 | 18 € | 670-EWEC5440250 | 74 € | 670-EWEC5450250 | 79 € |
| 300 | 670-EWEC130300 | 69 € | 670-EWEC140300 | 37 € | 670-EWEC150300 | 20 € | 670-EWEC5440300 | 95 € | 670-EWEC5450300 | 99 € |
| 350 | 670-EWEC130350 | 80 € | 670-EWEC140350 | 47 € | 670-EWEC150350 | 28 € | 670-EWEC5440350 | 107 € | 670-EWEC5450350 | 134 € |
| 400 | 670-EWEC130400 | 87 € | 670-EWEC140400 | 52 € | 670-EWEC150400 | 32 € | 670-EWEC5440400 | 116 € | 670-EWEC5450400 | 149 € |
| 450 | 670-EWEC130450 | 101 € | 670-EWEC140450 | 69 € | 670-EWEC150450 | 47 € | 670-EWEC5440450 | 148 € | 670-EWEC5450450 | 187 € |
| 500 | 670-EWEC130500 | 132 € | 670-EWEC140500 | 89 € | 670-EWEC150500 | 61 € | 670-EWEC5440500 | 176 € | 670-EWEC5450500 | 198 € |
| 550 | 670-EWEC130550 | 178 € | 670-EWEC140550 | 116 € | 670-EWEC150550 | 76 € | 670-EWEC5440550 | 187 € | 670-EWEC5450550 | 219 € |
| 600 | 670-EWEC130600 | 192 € | 670-EWEC140600 | 126 € | 670-EWEC150600 | 84 € | 670-EWEC5440600 | 214 € | 670-EWEC5450600 | 241 € |
| 650 | 670-EWEC130650 | 204 € | 670-EWEC140650 | 134 € | 670-EWEC150650 | 89 € | 670-EWEC5440650 | 227 € | 670-EWEC5450650 | 256 € |
| 700 | 670-EWEC130700 | 253 € | 670-EWEC140700 | 166 € | 670-EWEC150700 | 111 € | 670-EWEC5440700 | 282 € | 670-EWEC5450700 | 318 € |
| 750 | 670-EWEC130750 | 264 € | 670-EWEC140750 | 173 € | 670-EWEC150750 | 116 € | 670-EWEC5440750 | 295 € | 670-EWEC5450750 | 332 € |
| 800 | 670-EWEC130800 | 288 € | 670-EWEC140800 | 189 € | 670-EWEC150800 | 126 € | 670-EWEC5440800 | 322 € | 670-EWEC5450800 | 363 € |



Módulo de descenso



Módulo recto 250 mm
con desagüe lateral



Codo 15°



Codo 30°



Codo 45°

| Ø | CÓDIGO | € | CÓDIGO | € | CÓDIGO | € | CÓDIGO | € | CÓDIGO | € |
|-----|------------------|-------|-----------------|-------|----------------|-------|----------------|-------|----------------|-------|
| 80 | 670-EWEC14680080 | 37 € | 670-EWEC15D0080 | 15 € | 670-EWEC160080 | 13 € | 670-EWEC170080 | 13 € | 670-EWEC180080 | 13 € |
| 100 | 670-EWEC14680100 | 40 € | 670-EWEC15D0100 | 16 € | 670-EWEC160100 | 14 € | 670-EWEC170100 | 14 € | 670-EWEC180100 | 14 € |
| 130 | 670-EWEC14680130 | 44 € | 670-EWEC15D0130 | 16 € | 670-EWEC160130 | 15 € | 670-EWEC170130 | 15 € | 670-EWEC180130 | 15 € |
| 150 | 670-EWEC14680150 | 50 € | 670-EWEC15D0150 | 19 € | 670-EWEC160150 | 17 € | 670-EWEC170150 | 17 € | 670-EWEC180150 | 17 € |
| 180 | 670-EWEC14680180 | 59 € | 670-EWEC15D0180 | 20 € | 670-EWEC160180 | 22 € | 670-EWEC170180 | 22 € | 670-EWEC180180 | 22 € |
| 200 | 670-EWEC14680200 | 70 € | 670-EWEC15D0200 | 23 € | 670-EWEC160200 | 25 € | 670-EWEC170200 | 25 € | 670-EWEC180200 | 25 € |
| 250 | 670-EWEC14680250 | 94 € | 670-EWEC15D0250 | 26 € | 670-EWEC160250 | 32 € | 670-EWEC170250 | 32 € | 670-EWEC180250 | 32 € |
| 300 | 670-EWEC14680300 | 111 € | 670-EWEC15D0300 | 28 € | 670-EWEC160300 | 40 € | 670-EWEC170300 | 40 € | 670-EWEC180300 | 40 € |
| 350 | 670-EWEC14680350 | 129 € | 670-EWEC15D0350 | 37 € | 670-EWEC160350 | 48 € | 670-EWEC170350 | 48 € | 670-EWEC180350 | 48 € |
| 400 | 670-EWEC14680400 | 139 € | 670-EWEC15D0400 | 43 € | 670-EWEC160400 | 53 € | 670-EWEC170400 | 53 € | 670-EWEC180400 | 53 € |
| 450 | 670-EWEC14680450 | 162 € | 670-EWEC15D0450 | 57 € | 670-EWEC160450 | 75 € | 670-EWEC170450 | 75 € | 670-EWEC180450 | 75 € |
| 500 | 670-EWEC14680500 | 211 € | 670-EWEC15D0500 | 71 € | 670-EWEC160500 | 107 € | 670-EWEC170500 | 107 € | 670-EWEC180500 | 107 € |
| 550 | 670-EWEC14680550 | 284 € | 670-EWEC15D0550 | 87 € | 670-EWEC160550 | 139 € | 670-EWEC170550 | 139 € | 670-EWEC180550 | 139 € |
| 600 | 670-EWEC14680600 | 307 € | 670-EWEC15D0600 | 94 € | 670-EWEC160600 | 154 € | 670-EWEC170600 | 154 € | 670-EWEC180600 | 154 € |
| 650 | 670-EWEC14680650 | 326 € | 670-EWEC15D0650 | 104 € | 670-EWEC160650 | 163 € | 670-EWEC170650 | 163 € | 670-EWEC180650 | 163 € |
| 700 | 670-EWEC14680700 | 404 € | 670-EWEC15D0700 | 126 € | 670-EWEC160700 | 203 € | 670-EWEC170700 | 203 € | 670-EWEC180700 | 203 € |
| 750 | 670-EWEC14680750 | 423 € | 670-EWEC15D0750 | 132 € | 670-EWEC160750 | 212 € | 670-EWEC170750 | 212 € | 670-EWEC180750 | 212 € |
| 800 | 670-EWEC14680800 | 462 € | 670-EWEC15D0800 | 142 € | 670-EWEC160800 | 231 € | 670-EWEC170800 | 231 € | 670-EWEC180800 | 231 € |



93 699 46 04



pedidos@suministrosrado.com www.suministrosrado.com



Codo 60°



Codo 90°



Codo 90° Multidireccional (N1) 0-90°



Te 90°



Te 135°

| Ø | CÓDIGO | € | CÓDIGO | € | CÓDIGO | € | CÓDIGO | € | CÓDIGO | € |
|-----|----------------|-------|----------------|-------|-----------------|------|-----------------|-------|----------------|---------|
| 80 | 670-EWEC840080 | 15 € | 670-EWEC600080 | 17 € | 671-EWEC1010080 | 40 € | 670-EWEC3170080 | 27 € | 670-EWEC120080 | 39 € |
| 100 | 670-EWEC840100 | 16 € | 670-EWEC600100 | 17 € | 671-EWEC1010100 | 40 € | 670-EWEC3170100 | 31 € | 670-EWEC120100 | 42 € |
| 130 | 670-EWEC840130 | 17 € | 670-EWEC600130 | 18 € | 671-EWEC1010130 | 47 € | 670-EWEC3170130 | 33 € | 670-EWEC120130 | 44 € |
| 150 | 670-EWEC840150 | 21 € | 670-EWEC600150 | 24 € | 671-EWEC1010150 | 56 € | 670-EWEC3170150 | 41 € | 670-EWEC120150 | 55 € |
| 180 | 670-EWEC840180 | 27 € | 670-EWEC600180 | 32 € | 671-EWEC1010180 | 67 € | 670-EWEC3170180 | 48 € | 670-EWEC120180 | 66 € |
| 200 | 670-EWEC840200 | 30 € | 670-EWEC600200 | 34 € | 671-EWEC1010200 | 77 € | 670-EWEC3170200 | 55 € | 670-EWEC120200 | 75 € |
| 250 | 670-EWEC840250 | 39 € | 670-EWEC600250 | 45 € | 671-EWEC1010250 | 93 € | 670-EWEC3170250 | 66 € | 670-EWEC120250 | 95 € |
| 300 | 670-EWEC840300 | 50 € | 670-EWEC600300 | 59 € | - | - | 670-EWEC3170300 | 84 € | 670-EWEC120300 | 121 € |
| 350 | 670-EWEC840350 | 59 € | 670-EWEC600350 | 69 € | - | - | 670-EWEC3170350 | 91 € | 670-EWEC120350 | 132 € |
| 400 | 670-EWEC840400 | 67 € | 670-EWEC600400 | 79 € | - | - | 670-EWEC3170400 | 101 € | 670-EWEC120400 | 147 € |
| 450 | 670-EWEC840450 | 83 € | 670-EWEC600450 | 98 € | - | - | 670-EWEC3170450 | 148 € | 670-EWEC120450 | 229 € |
| 500 | 670-EWEC840500 | 107 € | 670-EWEC600500 | 126 € | - | - | 670-EWEC3170500 | 215 € | 670-EWEC120500 | 268 € |
| 550 | 670-EWEC840550 | 133 € | 670-EWEC600550 | 157 € | - | - | 670-EWEC3170550 | 279 € | 670-EWEC120550 | 348 € |
| 600 | 670-EWEC840600 | 158 € | 670-EWEC600600 | 187 € | - | - | 670-EWEC3170600 | 311 € | 670-EWEC120600 | 798 € |
| 650 | - | - | - | - | - | - | 670-EWEC3170650 | 330 € | 670-EWEC120650 | 846 € |
| 700 | - | - | - | - | - | - | 670-EWEC3170700 | 411 € | 670-EWEC120700 | 1.052 € |
| 750 | - | - | - | - | - | - | 670-EWEC3170750 | 429 € | 670-EWEC120750 | 1.100 € |
| 800 | - | - | - | - | - | - | 670-EWEC3170800 | 469 € | 670-EWEC120800 | 1.200 € |



Colector de hollín



Colector de hollín con desagüe



Módulo de inspección L=330 mm



Módulo temperatura humos L=330 mm



Módulo de inspección con tapa 200 Pa (PI)

| Ø | CÓDIGO | € | CÓDIGO | € | CÓDIGO | € | CÓDIGO | € | CÓDIGO | € |
|-----|-----------------|-------|----------------|-------|-----------------|-------|----------------|-------|-----------------|-------|
| 80 | 670-EWEC5510080 | 16 € | 670-EWEC440080 | 20 € | 670-EWEC5430080 | 19 € | 670-EWEC870080 | 100 € | 670-EWEC5490080 | 66 € |
| 100 | 670-EWEC5510100 | 17 € | 670-EWEC440100 | 22 € | 670-EWEC5430100 | 20 € | 670-EWEC870100 | 111 € | 670-EWEC5490100 | 73 € |
| 130 | 670-EWEC5510130 | 17 € | 670-EWEC440130 | 23 € | 670-EWEC5430130 | 22 € | 670-EWEC870130 | 123 € | 670-EWEC5490130 | 82 € |
| 150 | 670-EWEC5510150 | 17 € | 670-EWEC440150 | 25 € | 670-EWEC5430150 | 27 € | 670-EWEC870150 | 154 € | 670-EWEC5490150 | 101 € |
| 180 | 670-EWEC5510180 | 18 € | 670-EWEC440180 | 27 € | 670-EWEC5430180 | 33 € | 670-EWEC870180 | 184 € | 670-EWEC5490180 | 122 € |
| 200 | 670-EWEC5510200 | 22 € | 670-EWEC440200 | 30 € | 670-EWEC5430200 | 39 € | 670-EWEC870200 | 213 € | 670-EWEC5490200 | 139 € |
| 250 | 670-EWEC5510250 | 29 € | 670-EWEC440250 | 38 € | 670-EWEC5430250 | 48 € | 670-EWEC870250 | 265 € | 670-EWEC5490250 | 175 € |
| 300 | 670-EWEC5510300 | 37 € | 670-EWEC440300 | 47 € | 670-EWEC5430300 | 57 € | 670-EWEC870300 | 319 € | 670-EWEC5490300 | 210 € |
| 350 | 670-EWEC5510350 | 48 € | 670-EWEC440350 | 59 € | 670-EWEC5430350 | 63 € | 670-EWEC870350 | 350 € | 670-EWEC5490350 | 231 € |
| 400 | 670-EWEC5510400 | 73 € | 670-EWEC440400 | 98 € | 670-EWEC5430400 | 69 € | 670-EWEC870400 | 386 € | 670-EWEC5490400 | 254 € |
| 450 | 670-EWEC5510450 | 83 € | 670-EWEC440450 | 123 € | 670-EWEC5430450 | 96 € | 670-EWEC870450 | 420 € | 670-EWEC5490450 | 354 € |
| 500 | 670-EWEC5510500 | 90 € | 670-EWEC440500 | 136 € | 670-EWEC5430500 | 126 € | 670-EWEC870500 | 458 € | 670-EWEC5490500 | 461 € |
| 550 | 670-EWEC5510550 | 99 € | 670-EWEC440550 | 148 € | 670-EWEC5430550 | 142 € | 670-EWEC870550 | 500 € | 670-EWEC5490550 | 600 € |
| 600 | 670-EWEC5510600 | 109 € | 670-EWEC440600 | 160 € | 670-EWEC5430600 | 149 € | 670-EWEC870600 | 540 € | 670-EWEC5490600 | 650 € |
| 650 | 670-EWEC5510650 | 115 € | 670-EWEC440650 | 170 € | 670-EWEC5430650 | 156 € | 670-EWEC870650 | 573 € | 670-EWEC5490650 | 690 € |
| 700 | 670-EWEC5510700 | 143 € | 670-EWEC440700 | 212 € | 670-EWEC5430700 | 191 € | 670-EWEC870700 | 712 € | 670-EWEC5490700 | 857 € |
| 750 | 670-EWEC5510750 | 149 € | 670-EWEC440750 | 220 € | 670-EWEC5430750 | 204 € | 670-EWEC870750 | 744 € | 670-EWEC5490750 | 897 € |
| 800 | 670-EWEC5510800 | 163 € | 670-EWEC440800 | 241 € | 670-EWEC5430800 | 223 € | 670-EWEC870800 | 811 € | 670-EWEC5490800 | 978 € |



Sistema EW - ECO 304



Módulo de inspección
con tapa 40 Pa (NI)



Codo 90°
con inspección P1



Terminal salida libre



Terminal anti-lluvia



Terminal anti-viento

| Ø | CÓDIGO | € | CÓDIGO | € | CÓDIGO | € | CÓDIGO | € | CÓDIGO | € |
|-----|----------------|-------|------------------|-------|----------------|-------|-----------------|-------|-----------------|-------|
| 80 | 670-EWEC680080 | 37 € | 670-EWEC19AL0080 | 52 € | 670-EWEC320080 | 26 € | 670-EWEC5260080 | 37 € | 670-EWEC5270080 | 52 € |
| 100 | 670-EWEC680100 | 40 € | 670-EWEC19AL0100 | 55 € | 670-EWEC320100 | 28 € | 670-EWEC5260100 | 40 € | 670-EWEC5270100 | 57 € |
| 130 | 670-EWEC680130 | 44 € | 670-EWEC19AL0130 | 49 € | 670-EWEC320130 | 31 € | 670-EWEC5260130 | 44 € | 670-EWEC5270130 | 64 € |
| 150 | 670-EWEC680150 | 55 € | 670-EWEC19AL0150 | 66 € | 670-EWEC320150 | 40 € | 670-EWEC5260150 | 55 € | 670-EWEC5270150 | 79 € |
| 180 | 670-EWEC680180 | 66 € | 670-EWEC19AL0180 | 79 € | 670-EWEC320180 | 48 € | 670-EWEC5260180 | 66 € | 670-EWEC5270180 | 94 € |
| 200 | 670-EWEC680200 | 75 € | 670-EWEC19AL0200 | 103 € | 670-EWEC320200 | 55 € | 670-EWEC5260200 | 75 € | 670-EWEC5270200 | 109 € |
| 250 | 670-EWEC680250 | 95 € | 670-EWEC19AL0250 | 124 € | 670-EWEC320250 | 69 € | 670-EWEC5260250 | 95 € | 670-EWEC5270250 | 138 € |
| 300 | 670-EWEC680300 | 114 € | 670-EWEC19AL0300 | 137 € | 670-EWEC320300 | 83 € | 670-EWEC5260300 | 114 € | 670-EWEC5270300 | 163 € |
| 350 | 670-EWEC680350 | 125 € | 670-EWEC19AL0350 | 143 € | 670-EWEC320350 | 90 € | 670-EWEC5260350 | 125 € | 670-EWEC5270350 | 198 € |
| 400 | 670-EWEC680400 | 138 € | 670-EWEC19AL0400 | 163 € | 670-EWEC320400 | 100 € | 670-EWEC5260400 | 138 € | 670-EWEC5270400 | 219 € |
| 450 | 670-EWEC680450 | 193 € | 670-EWEC19AL0450 | 238 € | 670-EWEC320450 | 135 € | - | - | - | - |
| 500 | 670-EWEC680500 | 251 € | 670-EWEC19AL0500 | 297 € | 670-EWEC320500 | 169 € | - | - | - | - |
| 550 | 670-EWEC680550 | 327 € | 670-EWEC19AL0550 | 423 € | 670-EWEC320550 | 219 € | - | - | - | - |
| 600 | 670-EWEC680600 | 354 € | 670-EWEC19AL0600 | 498 € | 670-EWEC320600 | 237 € | - | - | - | - |
| 650 | 670-EWEC680650 | 375 € | - | - | 670-EWEC320650 | 252 € | - | - | - | - |
| 700 | 670-EWEC680700 | 466 € | - | - | 670-EWEC320700 | 312 € | - | - | - | - |
| 750 | 670-EWEC680750 | 487 € | - | - | 670-EWEC320750 | 327 € | - | - | - | - |
| 800 | 670-EWEC680800 | 531 € | - | - | 670-EWEC320800 | 356 € | - | - | - | - |



Terminal horizontal
con rejilla



Terminal Gas



Terminal Gas Light*



Manguito
hembra - hembra



Manguito
macho - macho

| Ø | CÓDIGO | € | CÓDIGO | € | CÓDIGO | € | CÓDIGO | € | CÓDIGO | € |
|-----|-----------------|-------|------------------|---------|------------------|-------|-----------------|-------|-----------------|-------|
| 80 | 670-EWEC5320080 | 29 € | - | - | 670-EWEC43500080 | 94 € | 670-EWEC6130080 | 8 € | 670-EWEC9720080 | 8 € |
| 100 | 670-EWEC5320100 | 31 € | - | - | 670-EWEC43500100 | 100 € | 670-EWEC6130100 | 11 € | 670-EWEC9720100 | 11 € |
| 130 | 670-EWEC5320130 | 36 € | 670-EWEC14540130 | 189 € | 670-EWEC43500130 | 110 € | 670-EWEC6130130 | 15 € | 670-EWEC9720130 | 15 € |
| 150 | 670-EWEC5320150 | 45 € | 670-EWEC14540150 | 210 € | 670-EWEC43500150 | 126 € | 670-EWEC6130150 | 18 € | 670-EWEC9720150 | 18 € |
| 180 | 670-EWEC5320180 | 54 € | 670-EWEC14540180 | 233 € | 670-EWEC43500180 | 138 € | 670-EWEC6130180 | 20 € | 670-EWEC9720180 | 20 € |
| 200 | 670-EWEC5320200 | 62 € | 670-EWEC14540200 | 293 € | 670-EWEC43500200 | 154 € | 670-EWEC6130200 | 22 € | 670-EWEC9720200 | 22 € |
| 250 | 670-EWEC5320250 | 77 € | 670-EWEC14540250 | 357 € | 670-EWEC43500250 | 204 € | 670-EWEC6130250 | 27 € | 670-EWEC9720250 | 27 € |
| 300 | 670-EWEC5320300 | 92 € | 670-EWEC14540300 | 409 € | 670-EWEC43500300 | 264 € | 670-EWEC6130300 | 33 € | 670-EWEC9720300 | 33 € |
| 350 | 670-EWEC5320350 | 100 € | 670-EWEC14540350 | 532 € | - | - | 670-EWEC6130350 | 40 € | 670-EWEC9720350 | 40 € |
| 400 | 670-EWEC5320400 | 113 € | 670-EWEC14540400 | 593 € | - | - | 670-EWEC6130400 | 44 € | 670-EWEC9720400 | 44 € |
| 450 | 670-EWEC5320450 | 150 € | 670-EWEC14540450 | 715 € | - | - | 670-EWEC6130450 | 49 € | 670-EWEC9720450 | 49 € |
| 500 | 670-EWEC5320500 | 189 € | 670-EWEC14540500 | 901 € | - | - | 670-EWEC6130500 | 61 € | 670-EWEC9720500 | 61 € |
| 550 | 670-EWEC5320550 | 246 € | 670-EWEC14540550 | 1.008 € | - | - | 670-EWEC6130550 | 126 € | 670-EWEC9720550 | 126 € |
| 600 | 670-EWEC5320600 | 265 € | 670-EWEC14540600 | 1.118 € | - | - | 670-EWEC6130600 | 134 € | 670-EWEC9720600 | 134 € |
| 650 | 670-EWEC5320650 | 281 € | 670-EWEC14540650 | 1.186 € | - | - | 670-EWEC6130650 | 142 € | 670-EWEC9720650 | 142 € |
| 700 | 670-EWEC5320700 | 349 € | 670-EWEC14540700 | 1.473 € | - | - | 670-EWEC6130700 | 177 € | 670-EWEC9720700 | 177 € |
| 750 | 670-EWEC5320750 | 365 € | 670-EWEC14540750 | 1.541 € | - | - | 670-EWEC6130750 | 185 € | 670-EWEC9720750 | 185 € |
| 800 | 670-EWEC5320800 | 398 € | 670-EWEC14540800 | 1.680 € | - | - | 670-EWEC6130800 | 202 € | 670-EWEC9720800 | 202 € |

* En los diámetros Ø80 y Ø100 las lamas sobresalen del diámetro del tubo.



93 699 46 04



pedidos@suministrosrado.com www.suministrosrado.com



Soporte de carga regulable L=220 mm



Abrazadera de unión 1.0



Abrazadera fijación pared sencilla



Abrazadera fijación pared regulable 50-80 mm



Abrazadera fijación pared fija

| Ø | CÓDIGO | € | CÓDIGO | € | CÓDIGO | € | CÓDIGO | € | CÓDIGO | € |
|-----|-----------------|-------|----------|------|-----------|-----|-----------|------|------------|-------|
| 80 | 670-EWEC3790080 | 34 € | EW450080 | 4 € | EW5350080 | 7 € | EW5560080 | 17 € | - | - |
| 100 | 670-EWEC3790100 | 38 € | EW450100 | 4 € | EW5350100 | 8 € | EW5560100 | 19 € | - | - |
| 130 | 670-EWEC3790130 | 42 € | EW450130 | 4 € | - | - | EW5560130 | 21 € | - | - |
| 150 | 670-EWEC3790150 | 51 € | EW450150 | 5 € | - | - | EW5560150 | 22 € | - | - |
| 180 | 670-EWEC3790180 | 63 € | EW450180 | 6 € | - | - | EW5560180 | 22 € | - | - |
| 200 | 670-EWEC3790200 | 71 € | EW450200 | 7 € | - | - | EW5560200 | 25 € | - | - |
| 250 | 670-EWEC3790250 | 90 € | EW450250 | 11 € | - | - | EW5560250 | 34 € | - | - |
| 300 | 670-EWEC3790300 | 108 € | EW450300 | 14 € | - | - | EW5560300 | 36 € | - | - |
| 350 | 670-EWEC3790350 | 118 € | EW450350 | 16 € | - | - | EW5560350 | 39 € | - | - |
| 400 | 670-EWEC3790400 | 130 € | EW450400 | 21 € | - | - | EW5560400 | 49 € | - | - |
| 450 | 670-EWEC3790450 | 188 € | EW450450 | 24 € | - | - | EW5560450 | 55 € | - | - |
| 500 | 670-EWEC3790500 | 263 € | EW450500 | 26 € | - | - | - | - | EW556F0500 | 71 € |
| 550 | 670-EWEC3790550 | 380 € | EW450550 | 28 € | - | - | - | - | EW556F0550 | 88 € |
| 600 | 670-EWEC3790600 | 413 € | EW450600 | 33 € | - | - | - | - | EW556F0600 | 105 € |
| 650 | 670-EWEC3790650 | 438 € | EW450650 | 36 € | - | - | - | - | EW556F0650 | 115 € |
| 700 | 670-EWEC3790700 | 543 € | EW450700 | 43 € | - | - | - | - | EW556F0700 | 149 € |
| 750 | 670-EWEC3790750 | 568 € | EW450750 | 52 € | - | - | - | - | EW556F0750 | 183 € |
| 800 | 670-EWEC3790800 | 620 € | EW450800 | 59 € | - | - | - | - | EW556F0800 | 204 € |



Abrazadera de amarre por tornillo



Base de abrazadera distanciadora*



Alas distanciadoras A*



Alas distanciadoras B*



Alas distanciadoras C*

| Ø | CÓDIGO | € | CÓDIGO | € | CÓDIGO | € | CÓDIGO | € | CÓDIGO | € |
|-----|------------|-------|------------|-------|---------------|------|---------------|------|---------------|------|
| 80 | EW10630080 | 14 € | EW14620080 | 22 € | 665-ZUWA1462A | 26 € | 665-ZUWA1462B | 37 € | 665-ZUWA1462C | 46 € |
| 100 | EW10630100 | 16 € | EW14620100 | 23 € | | | | | | |
| 130 | EW10630130 | 18 € | EW14620130 | 25 € | | | | | | |
| 150 | EW10630150 | 20 € | EW14620150 | 27 € | | | | | | |
| 180 | EW10630180 | 22 € | EW14620180 | 29 € | | | | | | |
| 200 | EW10630200 | 24 € | EW14620200 | 32 € | | | | | | |
| 250 | EW10630250 | 28 € | EW14620250 | 57 € | | | | | | |
| 300 | EW10630300 | 37 € | EW14620300 | 77 € | | | | | | |
| 350 | EW10630350 | 42 € | EW14620350 | 105 € | | | | | | |
| 400 | EW10630400 | 48 € | EW14620400 | 137 € | | | | | | |
| 450 | EW10630450 | 54 € | EW14620450 | 170 € | | | | | | |
| 500 | EW10630500 | 60 € | EW14620500 | 186 € | | | | | | |
| 550 | EW10630550 | 66 € | EW14620550 | 208 € | | | | | | |
| 600 | EW10630600 | 72 € | EW14620600 | 235 € | | | | | | |
| 650 | EW10630650 | 78 € | EW14620650 | 253 € | | | | | | |
| 700 | EW10630700 | 86 € | EW14620700 | 327 € | | | | | | |
| 750 | EW10630750 | 95 € | EW14620750 | 334 € | | | | | | |
| 800 | EW10630800 | 101 € | EW14620800 | 448 € | | | | | | |



Sistema EW - ECO 304



Alas distanciadoras D*



Abrazadera de araña



Abrazadera forjado inox



Abrazadera de soporte



Abrazadera de descenso

| Ø | CÓDIGO | € | CÓDIGO | € | CÓDIGO | € | CÓDIGO | € | CÓDIGO | € |
|-----|---------------|-------|----------|------|-----------|-------|-----------|-------|-----------|-------|
| 80 | 665-ZUWA1462D | 59 € | EW400080 | 6 € | EW620080 | 9 € | - | - | EW40D0080 | 8 € |
| 100 | | | EW400100 | 6 € | EW620100 | 11 € | - | - | EW40D0100 | 8 € |
| 130 | | | EW400130 | 6 € | EW620130 | 14 € | - | - | EW40D0130 | 8 € |
| 150 | | | EW400150 | 6 € | EW620150 | 17 € | - | - | EW40D0150 | 10 € |
| 180 | | | EW400180 | 8 € | EW620180 | 24 € | EW8580180 | 83 € | EW40D0180 | 13 € |
| 200 | | | EW400200 | 8 € | EW620200 | 26 € | EW8580200 | 83 € | EW40D0200 | 15 € |
| 250 | | | EW400250 | 14 € | EW620250 | 28 € | EW8580250 | 105 € | EW40D0250 | 23 € |
| 300 | | | EW400300 | 16 € | EW620300 | 33 € | EW8580300 | 115 € | EW40D0300 | 27 € |
| 350 | | | EW400350 | 19 € | EW620350 | 38 € | EW8580350 | 126 € | EW40D0350 | 31 € |
| 400 | | | EW400400 | 21 € | EW620400 | 42 € | EW8580400 | 154 € | EW40D0400 | 42 € |
| 450 | | | EW400450 | 23 € | - | - | EW8580450 | 183 € | EW40D0450 | 48 € |
| 500 | | | EW400500 | 31 € | - | - | EW8580500 | 201 € | EW40D0500 | 52 € |
| 550 | | | EW400550 | 42 € | - | - | EW8580550 | 229 € | EW40D0550 | 56 € |
| 600 | | | EW400600 | 55 € | - | - | EW8580600 | 259 € | EW40D0600 | 67 € |
| 650 | | | EW400650 | 60 € | - | - | EW8580650 | 280 € | EW40D0650 | 71 € |
| 700 | | | EW400700 | 77 € | - | - | EW8580700 | 363 € | EW40D0700 | 86 € |
| 750 | | | EW400750 | 94 € | - | - | EW8580750 | 444 € | EW40D0750 | 105 € |
| 800 | EW400800 | 106 € | - | - | EW8580800 | 497 € | EW40D0800 | 117 € | | |

* Consultar página 177 para ver distancias de separación



Soporte de techo



Abrazadera con doble pértiga telescópica



Abrazadera vientos



Pasamuros



Cubreaguas plano inox

| Ø | CÓDIGO | € | CÓDIGO | € | CÓDIGO | € | CÓDIGO | € | CÓDIGO | € |
|-----|-----------|-------|-----------|-------|----------|-------|-----------|-------|------------|-------|
| 80 | EW9360080 | 16 € | - | - | EW420080 | 6 € | EW9870080 | 17 € | EW11280080 | 115 € |
| 100 | EW9360100 | 18 € | - | - | EW420100 | 6 € | EW9870100 | 21 € | EW11280100 | 116 € |
| 130 | EW9360130 | 19 € | EW1910130 | 82 € | EW420130 | 7 € | EW9870130 | 22 € | EW11280130 | 117 € |
| 150 | EW9360150 | 23 € | EW1910150 | 84 € | EW420150 | 8 € | EW9870150 | 23 € | EW11280150 | 118 € |
| 180 | EW9360180 | 28 € | EW1910180 | 89 € | EW420180 | 11 € | EW9870180 | 29 € | EW11280180 | 133 € |
| 200 | EW9360200 | 31 € | EW1910200 | 98 € | EW420200 | 14 € | EW9870200 | 29 € | EW11280200 | 147 € |
| 250 | EW9360250 | 41 € | EW1910250 | 111 € | EW420250 | 16 € | EW9870250 | 37 € | EW11280250 | 167 € |
| 300 | EW9360300 | 48 € | EW1910300 | 132 € | EW420300 | 19 € | EW9870300 | 47 € | EW11280300 | 185 € |
| 350 | EW9360350 | 52 € | EW1910350 | 142 € | EW420350 | 21 € | EW9870350 | 52 € | EW11280350 | 205 € |
| 400 | EW9360400 | 59 € | EW1910400 | 156 € | EW420400 | 23 € | EW9870400 | 69 € | EW11280400 | 225 € |
| 450 | EW9360450 | 82 € | EW1910450 | 217 € | EW420450 | 31 € | EW9870450 | 89 € | EW11280450 | 243 € |
| 500 | EW9360500 | 106 € | EW1910500 | 282 € | EW420500 | 42 € | EW9870500 | 116 € | EW11280500 | 278 € |
| 550 | EW9360550 | 137 € | EW1910550 | 368 € | EW420550 | 55 € | EW9870550 | 126 € | EW11280550 | 307 € |
| 600 | EW9360600 | 149 € | EW1910600 | 399 € | EW420600 | 60 € | EW9870600 | 139 € | EW11280600 | 346 € |
| 650 | EW9360650 | 162 € | EW1910650 | 437 € | EW420650 | 66 € | EW9870650 | 155 € | EW11280650 | 389 € |
| 700 | EW9360700 | 187 € | EW1910700 | 498 € | EW420700 | 86 € | EW9870700 | 193 € | EW11280700 | 436 € |
| 750 | EW9360750 | 210 € | EW1910750 | 557 € | EW420750 | 105 € | EW9870750 | 227 € | EW11280750 | 464 € |
| 800 | EW9360800 | 241 € | EW1910800 | 643 € | EW420800 | 116 € | EW9870800 | 266 € | EW11280800 | 485 € |



93 699 46 04



pedidos@suministrosrado.com www.suministrosrado.com



Cubreaguas plomo
0° - 5°



Cubreaguas plomo
5° - 25°

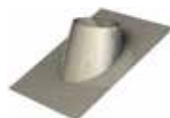

Cubreaguas plomo
25° - 45°



Cubreaguas
5° - 25° aluminio

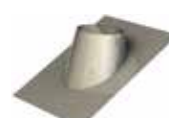

Cubreaguas
25° - 45° aluminio

| Ø | CÓDIGO | € | CÓDIGO | € | CÓDIGO | € | CÓDIGO | € | CÓDIGO | € |
|-----|-----------|-------|-----------|-------|-----------|-------|-------------|-------|-------------|-------|
| 80 | EW9370080 | 115 € | EW9380080 | 115 € | EW9390080 | 198 € | EW938AL0080 | 67 € | EW939AL0080 | 115 € |
| 100 | EW9370100 | 116 € | EW9380100 | 116 € | EW9390100 | 202 € | EW938AL0100 | 69 € | EW939AL0100 | 119 € |
| 130 | EW9370130 | 117 € | EW9380130 | 117 € | EW9390130 | 204 € | EW938AL0130 | 79 € | EW939AL0130 | 137 € |
| 150 | EW9370150 | 118 € | EW9380150 | 118 € | EW9390150 | 206 € | EW938AL0150 | 85 € | EW939AL0150 | 138 € |
| 180 | EW9370180 | 133 € | EW9380180 | 133 € | EW9390180 | 216 € | EW938AL0180 | 93 € | EW939AL0180 | 144 € |
| 200 | EW9370200 | 147 € | EW9380200 | 147 € | EW9390200 | 219 € | EW938AL0200 | 102 € | EW939AL0200 | 146 € |
| 250 | EW9370250 | 167 € | EW9380250 | 167 € | EW9390250 | 229 € | EW938AL0250 | 111 € | EW939AL0250 | 154 € |
| 300 | EW9370300 | 185 € | EW9380300 | 185 € | EW9390300 | 239 € | EW938AL0300 | 134 € | EW939AL0300 | 186 € |
| 350 | EW9370350 | 205 € | EW9380350 | 205 € | EW9390350 | 245 € | EW938AL0350 | 141 € | EW939AL0350 | 195 € |
| 400 | EW9370400 | 225 € | EW9380400 | 225 € | EW9390400 | 259 € | EW938AL0400 | 170 € | EW939AL0400 | 236 € |
| 450 | EW9370450 | 243 € | EW9380450 | 243 € | EW9390450 | 309 € | EW938AL0450 | 186 € | EW939AL0450 | 258 € |
| 500 | EW9370500 | 278 € | EW9380500 | 278 € | EW9390500 | 353 € | EW938AL0500 | 254 € | EW939AL0500 | 352 € |
| 550 | EW9370550 | 307 € | EW9380550 | 307 € | EW9390550 | 394 € | EW938AL0550 | 286 € | EW939AL0550 | 397 € |
| 600 | EW9370600 | 346 € | EW9380600 | 346 € | EW9390600 | 442 € | EW938AL0600 | 304 € | EW939AL0600 | 422 € |
| 650 | EW9370650 | 389 € | EW9380650 | 389 € | EW9390650 | 496 € | EW938AL0650 | 378 € | EW939AL0650 | 525 € |
| 700 | EW9370700 | 436 € | EW9380700 | 436 € | EW9390700 | 556 € | EW938AL0700 | 455 € | EW939AL0700 | 630 € |
| 750 | EW9370750 | 464 € | EW9380750 | 464 € | EW9390750 | 591 € | EW938AL0750 | 467 € | EW939AL0750 | 648 € |
| 800 | EW9370800 | 485 € | EW9380800 | 485 € | EW9390800 | 617 € | EW938AL0800 | 543 € | EW939AL0800 | 753 € |



Collarín antitormenta



Junta de estanqueidad
(T<200°C)

| Ø | CÓDIGO | € | CÓDIGO | € |
|-----|-----------|-------|----------|------|
| 80 | EW3070080 | 14 € | EW260080 | 3 € |
| 100 | EW3070100 | 15 € | EW260100 | 3 € |
| 130 | EW3070130 | 16 € | EW260130 | 3 € |
| 150 | EW3070150 | 19 € | EW260150 | 3 € |
| 180 | EW3070180 | 23 € | EW260180 | 4 € |
| 200 | EW3070200 | 26 € | EW260200 | 5 € |
| 250 | EW3070250 | 33 € | EW260250 | 7 € |
| 300 | EW3070300 | 40 € | EW260300 | 8 € |
| 350 | EW3070350 | 43 € | EW260350 | 9 € |
| 400 | EW3070400 | 47 € | EW260400 | 10 € |
| 450 | EW3070450 | 66 € | EW260450 | 11 € |
| 500 | EW3070500 | 86 € | EW260500 | 13 € |
| 550 | EW3070550 | 112 € | EW260550 | 15 € |
| 600 | EW3070600 | 121 € | EW260600 | 17 € |
| 650 | EW3070650 | 133 € | EW260650 | 20 € |
| 700 | EW3070700 | 152 € | EW260700 | 23 € |
| 750 | EW3070750 | 169 € | EW260750 | 25 € |
| 800 | EW3070800 | 195 € | EW260800 | 27 € |



Sistema EW - ECO 304

ADAPTADOR CALDERA HEMBRA

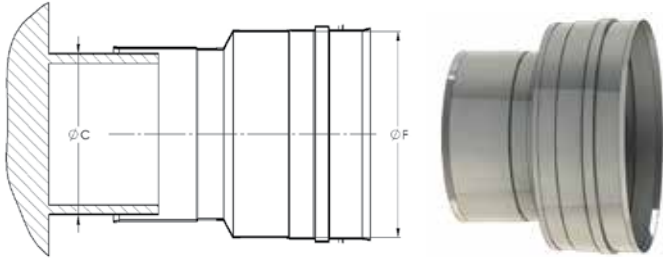

| CÓDIGO | ØC CALDERA | ØF CHIMENEA | € |
|---------------------|------------|-------------|------|
| 670-EWEC37H00800080 | 78 a 82 | 80 | 12 € |
| 670-EWEC37H00800100 | 78 a 82 | 100 | 30 € |
| 670-EWEC37H00800130 | 78 a 82 | 130 | 31 € |
| 670-EWEC37H01000080 | 98 a 102 | 80 | 30 € |
| 670-EWEC37H01000100 | 98 a 102 | 100 | 13 € |
| 670-EWEC37H01000130 | 98 a 102 | 130 | 31 € |
| 670-EWEC37H01000150 | 98 a 102 | 150 | 36 € |
| 670-EWEC37H01000080 | 108 a 112 | 80 | 30 € |
| 670-EWEC37H01100100 | 108 a 112 | 100 | 32 € |
| 670-EWEC37H01100130 | 108 a 112 | 130 | 31 € |
| 670-EWEC37H01100150 | 108 a 112 | 150 | 36 € |
| 670-EWEC37H01200080 | 118 a 122 | 80 | 31 € |
| 670-EWEC37H01200100 | 118 a 122 | 100 | 32 € |
| 670-EWEC37H01200130 | 118 a 122 | 130 | 31 € |
| 670-EWEC37H01200150 | 118 a 122 | 150 | 36 € |
| 670-EWEC37H01250080 | 123 a 127 | 80 | 31 € |
| 670-EWEC37H01250100 | 123 a 127 | 100 | 32 € |
| 670-EWEC37H01250130 | 123 a 127 | 130 | 14 € |
| 670-EWEC37H01250150 | 123 a 127 | 150 | 36 € |
| 670-EWEC37H01300080 | 128 a 132 | 80 | 31 € |
| 670-EWEC37H01300100 | 128 a 132 | 100 | 32 € |
| 670-EWEC37H01300130 | 128 a 132 | 130 | 14 € |
| 670-EWEC37H01300150 | 128 a 132 | 150 | 37 € |
| 670-EWEC37H01300180 | 128 a 132 | 180 | 43 € |
| 670-EWEC37H01350080 | 133 a 137 | 80 | 44 € |
| 670-EWEC37H01350100 | 133 a 137 | 100 | 40 € |
| 670-EWEC37H01350130 | 133 a 137 | 130 | 14 € |
| 670-EWEC37H01350150 | 133 a 137 | 150 | 37 € |
| 670-EWEC37H01350180 | 133 a 137 | 180 | 43 € |
| 670-EWEC37H01400080 | 138 a 142 | 80 | 71 € |
| 670-EWEC37H01400100 | 138 a 142 | 100 | 40 € |
| 670-EWEC37H01400130 | 138 a 142 | 130 | 40 € |
| 670-EWEC37H01400150 | 138 a 142 | 150 | 16 € |
| 670-EWEC37H01400180 | 138 a 142 | 180 | 43 € |
| 670-EWEC37H01500080 | 148 a 152 | 80 | 71 € |
| 670-EWEC37H01500100 | 148 a 152 | 100 | 40 € |
| 670-EWEC37H01500130 | 148 a 152 | 130 | 40 € |
| 670-EWEC37H01500150 | 148 a 152 | 150 | 16 € |
| 670-EWEC37H01500180 | 148 a 152 | 180 | 44 € |
| 670-EWEC37H01500200 | 148 a 152 | 200 | 50 € |
| 670-EWEC37H01600080 | 158 a 162 | 80 | 82 € |
| 670-EWEC37H01600100 | 158 a 162 | 100 | 47 € |
| 670-EWEC37H01600130 | 158 a 162 | 130 | 47 € |
| 670-EWEC37H01600150 | 158 a 162 | 150 | 16 € |
| 670-EWEC37H01600180 | 158 a 162 | 180 | 44 € |
| 670-EWEC37H01600200 | 158 a 162 | 200 | 50 € |
| 670-EWEC37H01750080 | 173 a 177 | 80 | 82 € |

| CÓDIGO | ØC CALDERA | ØF CHIMENEA | € |
|---------------------|------------|-------------|-------|
| 670-EWEC37H01750100 | 173 a 177 | 100 | 47 € |
| 670-EWEC37H01750130 | 173 a 177 | 130 | 47 € |
| 670-EWEC37H01750150 | 173 a 177 | 150 | 45 € |
| 670-EWEC37H01750180 | 173 a 177 | 180 | 19 € |
| 670-EWEC37H01750200 | 173 a 177 | 200 | 50 € |
| 670-EWEC37H01800080 | 178 a 182 | 80 | 82 € |
| 670-EWEC37H01800100 | 178 a 182 | 100 | 47 € |
| 670-EWEC37H01800130 | 178 a 182 | 130 | 47 € |
| 670-EWEC37H01800150 | 178 a 182 | 150 | 45 € |
| 670-EWEC37H01800180 | 178 a 182 | 180 | 19 € |
| 670-EWEC37H01800200 | 178 a 182 | 200 | 51 € |
| 670-EWEC37H01800250 | 178 a 182 | 250 | 54 € |
| 670-EWEC37H02000150 | 198 a 202 | 150 | 51 € |
| 670-EWEC37H02000180 | 198 a 202 | 180 | 50 € |
| 670-EWEC37H02000200 | 198 a 202 | 200 | 22 € |
| 670-EWEC37H02000250 | 198 a 202 | 250 | 55 € |
| 670-EWEC37H02000300 | 198 a 202 | 300 | 71 € |
| 670-EWEC37H02250180 | 223 a 227 | 180 | 53 € |
| 670-EWEC37H02250200 | 223 a 227 | 200 | 53 € |
| 670-EWEC37H02250250 | 223 a 227 | 250 | 55 € |
| 670-EWEC37H02250300 | 223 a 227 | 300 | 71 € |
| 670-EWEC37H02500180 | 248 a 252 | 180 | 53 € |
| 670-EWEC37H02500200 | 248 a 252 | 200 | 53 € |
| 670-EWEC37H02500250 | 248 a 252 | 250 | 27 € |
| 670-EWEC37H02500300 | 248 a 252 | 300 | 72 € |
| 670-EWEC37H02500350 | 248 a 252 | 350 | 75 € |
| 670-EWEC37H03000200 | 298 a 302 | 200 | 71 € |
| 670-EWEC37H03000250 | 298 a 302 | 250 | 74 € |
| 670-EWEC37H03000300 | 298 a 302 | 300 | 31 € |
| 670-EWEC37H03000350 | 298 a 302 | 350 | 76 € |
| 670-EWEC37H03000400 | 298 a 302 | 400 | 90 € |
| 670-EWEC37H03500250 | 348 a 352 | 250 | 84 € |
| 670-EWEC37H03500300 | 348 a 352 | 300 | 85 € |
| 670-EWEC37H03500350 | 348 a 352 | 350 | 36 € |
| 670-EWEC37H03500400 | 348 a 352 | 400 | 93 € |
| 670-EWEC37H03500450 | 348 a 352 | 450 | 147 € |
| 670-EWEC37H04000300 | 398 a 402 | 300 | 94 € |
| 670-EWEC37H04000350 | 398 a 402 | 350 | 89 € |
| 670-EWEC37H04000400 | 398 a 402 | 400 | 40 € |
| 670-EWEC37H04000450 | 398 a 402 | 450 | 149 € |
| 670-EWEC37H04000500 | 398 a 402 | 500 | 201 € |
| 670-EWEC37H04500350 | 448 a 452 | 350 | 122 € |
| 670-EWEC37H04500400 | 448 a 452 | 400 | 129 € |
| 670-EWEC37H04500450 | 448 a 452 | 450 | 55 € |
| 670-EWEC37H04500500 | 448 a 452 | 500 | 204 € |
| 670-EWEC37H04500550 | 448 a 452 | 550 | 366 € |
| 670-EWEC37H05000400 | 498 a 502 | 400 | 131 € |
| 670-EWEC37H05000450 | 498 a 502 | 450 | 155 € |
| 670-EWEC37H05000500 | 498 a 502 | 500 | 78 € |
| 670-EWEC37H05000550 | 498 a 502 | 550 | 369 € |
| 670-EWEC37H05000600 | 498 a 502 | 600 | 329 € |
| 670-EWEC37H05500450 | 548 a 552 | 450 | 226 € |
| 670-EWEC37H05500500 | 548 a 552 | 500 | 302 € |
| 670-EWEC37H05500550 | 548 a 552 | 550 | 109 € |
| 670-EWEC37H05500600 | 548 a 552 | 600 | 331 € |
| 670-EWEC37H05500650 | 548 a 552 | 650 | 356 € |
| 670-EWEC37H06000500 | 598 a 602 | 500 | 312 € |
| 670-EWEC37H06000550 | 598 a 602 | 550 | 385 € |
| 670-EWEC37H06000600 | 598 a 602 | 600 | 109 € |
| 670-EWEC37H06000650 | 598 a 602 | 650 | 358 € |
| 670-EWEC37H06000700 | 598 a 602 | 700 | 384 € |
| 670-EWEC37H06500650 | 648 a 652 | 650 | 118 € |
| 670-EWEC37H06500700 | 648 a 652 | 700 | 386 € |
| 670-EWEC37H06500750 | 648 a 652 | 750 | 411 € |
| 670-EWEC37H07000700 | 698 a 702 | 700 | 127 € |
| 670-EWEC37H07000750 | 698 a 702 | 750 | 413 € |
| 670-EWEC37H07000800 | 698 a 702 | 800 | 438 € |
| 670-EWEC37H07500750 | 748 a 752 | 750 | 137 € |
| 670-EWEC37H07500800 | 748 a 752 | 800 | 440 € |
| 670-EWEC37H08000800 | 798 a 802 | 800 | 146 € |



ADAPTADOR CALDERA MACHO

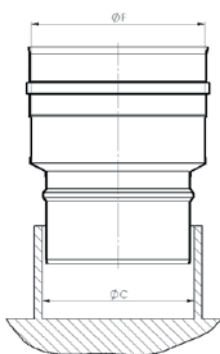

| CÓDIGO | ØC CALDERA | ØF CHIMENEA | € |
|---------------------|------------|-------------|------|
| 670-EWEC37M00800080 | 78 a 82 | 80 | 12 € |
| 670-EWEC37M00800100 | 78 a 82 | 100 | 30 € |
| 670-EWEC37M00800130 | 78 a 82 | 130 | 31 € |
| 670-EWEC37M01000080 | 98 a 102 | 80 | 30 € |
| 670-EWEC37M01000100 | 98 a 102 | 100 | 13 € |
| 670-EWEC37M01000130 | 98 a 102 | 130 | 31 € |
| 670-EWEC37M01000150 | 98 a 102 | 150 | 36 € |
| 670-EWEC37M01100080 | 108 a 112 | 80 | 30 € |
| 670-EWEC37M01100100 | 108 a 112 | 100 | 32 € |
| 670-EWEC37M01100130 | 108 a 112 | 130 | 31 € |
| 670-EWEC37M01100150 | 108 a 112 | 150 | 36 € |
| 670-EWEC37M01200080 | 118 a 122 | 80 | 31 € |
| 670-EWEC37M01200100 | 118 a 122 | 100 | 32 € |
| 670-EWEC37M01200130 | 118 a 122 | 130 | 31 € |
| 670-EWEC37M01200150 | 118 a 122 | 150 | 36 € |
| 670-EWEC37M01250080 | 123 a 127 | 80 | 31 € |
| 670-EWEC37M01250100 | 123 a 127 | 100 | 32 € |
| 670-EWEC37M01250130 | 123 a 127 | 130 | 14 € |
| 670-EWEC37M01250150 | 123 a 127 | 150 | 36 € |
| 670-EWEC37M01300080 | 128 a 132 | 80 | 31 € |
| 670-EWEC37M01300100 | 128 a 132 | 100 | 32 € |
| 670-EWEC37M01300130 | 128 a 132 | 130 | 14 € |
| 670-EWEC37M01300150 | 128 a 132 | 150 | 37 € |
| 670-EWEC37M01300180 | 128 a 132 | 180 | 43 € |
| 670-EWEC37M01350080 | 133 a 137 | 80 | 44 € |
| 670-EWEC37M01350100 | 133 a 137 | 100 | 40 € |
| 670-EWEC37M01350130 | 133 a 137 | 130 | 14 € |
| 670-EWEC37M01350150 | 133 a 137 | 150 | 37 € |
| 670-EWEC37M01350180 | 133 a 137 | 180 | 43 € |
| 670-EWEC37M01400080 | 138 a 142 | 80 | 71 € |
| 670-EWEC37M01400100 | 138 a 142 | 100 | 40 € |
| 670-EWEC37M01400130 | 138 a 142 | 130 | 40 € |
| 670-EWEC37M01400150 | 138 a 142 | 150 | 16 € |
| 670-EWEC37M01400180 | 138 a 142 | 180 | 43 € |
| 670-EWEC37M01500080 | 148 a 152 | 80 | 71 € |
| 670-EWEC37M01500100 | 148 a 152 | 100 | 40 € |
| 670-EWEC37M01500130 | 148 a 152 | 130 | 40 € |
| 670-EWEC37M01500150 | 148 a 152 | 150 | 16 € |
| 670-EWEC37M01500180 | 148 a 152 | 180 | 44 € |
| 670-EWEC37M01500200 | 148 a 152 | 200 | 50 € |
| 670-EWEC37M01600080 | 158 a 162 | 80 | 82 € |
| 670-EWEC37M01600100 | 158 a 162 | 100 | 47 € |
| 670-EWEC37M01600130 | 158 a 162 | 130 | 47 € |
| 670-EWEC37M01600150 | 158 a 162 | 150 | 16 € |
| 670-EWEC37M01600180 | 158 a 162 | 180 | 44 € |
| 670-EWEC37M01600200 | 158 a 162 | 200 | 50 € |
| 670-EWEC37M01750080 | 173 a 177 | 80 | 82 € |

| CÓDIGO | ØC CALDERA | ØF CHIMENEA | € |
|---------------------|------------|-------------|-------|
| 670-EWEC37M01750100 | 173 a 177 | 100 | 47 € |
| 670-EWEC37M01750130 | 173 a 177 | 130 | 47 € |
| 670-EWEC37M01750150 | 173 a 177 | 150 | 45 € |
| 670-EWEC37M01750180 | 173 a 177 | 180 | 19 € |
| 670-EWEC37M01750200 | 173 a 177 | 200 | 50 € |
| 670-EWEC37M01800080 | 178 a 182 | 80 | 82 € |
| 670-EWEC37M01800100 | 178 a 182 | 100 | 47 € |
| 670-EWEC37M01800130 | 178 a 182 | 130 | 47 € |
| 670-EWEC37M01800150 | 178 a 182 | 150 | 45 € |
| 670-EWEC37M01800180 | 178 a 182 | 180 | 19 € |
| 670-EWEC37M01800200 | 178 a 182 | 200 | 51 € |
| 670-EWEC37M01800250 | 178 a 182 | 250 | 54 € |
| 670-EWEC37M02000150 | 198 a 202 | 150 | 51 € |
| 670-EWEC37M02000180 | 198 a 202 | 180 | 50 € |
| 670-EWEC37M02000200 | 198 a 202 | 200 | 22 € |
| 670-EWEC37M02000250 | 198 a 202 | 250 | 55 € |
| 670-EWEC37M02000300 | 198 a 202 | 300 | 71 € |
| 670-EWEC37M02250180 | 223 a 227 | 180 | 53 € |
| 670-EWEC37M02250200 | 223 a 227 | 200 | 53 € |
| 670-EWEC37M02250250 | 223 a 227 | 250 | 55 € |
| 670-EWEC37M02250300 | 223 a 227 | 300 | 71 € |
| 670-EWEC37M02500180 | 248 a 252 | 180 | 53 € |
| 670-EWEC37M02500200 | 248 a 252 | 200 | 53 € |
| 670-EWEC37M02500250 | 248 a 252 | 250 | 27 € |
| 670-EWEC37M02500300 | 248 a 252 | 300 | 72 € |
| 670-EWEC37M02500350 | 248 a 252 | 350 | 75 € |
| 670-EWEC37M03000200 | 298 a 302 | 200 | 71 € |
| 670-EWEC37M03000250 | 298 a 302 | 250 | 74 € |
| 670-EWEC37M03000300 | 298 a 302 | 300 | 31 € |
| 670-EWEC37M03000350 | 298 a 302 | 350 | 76 € |
| 670-EWEC37M03000400 | 298 a 302 | 400 | 90 € |
| 670-EWEC37M03500250 | 348 a 352 | 250 | 84 € |
| 670-EWEC37M03500300 | 348 a 352 | 300 | 85 € |
| 670-EWEC37M03500350 | 348 a 352 | 350 | 36 € |
| 670-EWEC37M03500400 | 348 a 352 | 400 | 93 € |
| 670-EWEC37M03500450 | 348 a 352 | 450 | 147 € |
| 670-EWEC37M04000300 | 398 a 402 | 300 | 94 € |
| 670-EWEC37M04000350 | 398 a 402 | 350 | 89 € |
| 670-EWEC37M04000400 | 398 a 402 | 400 | 40 € |
| 670-EWEC37M04000450 | 398 a 402 | 450 | 149 € |
| 670-EWEC37M04000500 | 398 a 402 | 500 | 201 € |
| 670-EWEC37M04500350 | 448 a 452 | 350 | 122 € |
| 670-EWEC37M04500400 | 448 a 452 | 400 | 129 € |
| 670-EWEC37M04500450 | 448 a 452 | 450 | 55 € |
| 670-EWEC37M04500500 | 448 a 452 | 500 | 204 € |
| 670-EWEC37M04500550 | 448 a 452 | 550 | 366 € |
| 670-EWEC37M05000400 | 498 a 502 | 400 | 131 € |
| 670-EWEC37M05000450 | 498 a 502 | 450 | 155 € |
| 670-EWEC37M05000500 | 498 a 502 | 500 | 78 € |
| 670-EWEC37M05000550 | 498 a 502 | 550 | 369 € |
| 670-EWEC37M05000600 | 498 a 502 | 600 | 329 € |
| 670-EWEC37M05500450 | 548 a 552 | 450 | 226 € |
| 670-EWEC37M05500500 | 548 a 552 | 500 | 302 € |
| 670-EWEC37M05500550 | 548 a 552 | 550 | 109 € |
| 670-EWEC37M05500600 | 548 a 552 | 600 | 331 € |
| 670-EWEC37M05500650 | 548 a 552 | 650 | 356 € |
| 670-EWEC37M06000500 | 598 a 602 | 500 | 312 € |
| 670-EWEC37M06000550 | 598 a 602 | 550 | 385 € |
| 670-EWEC37M06000600 | 598 a 602 | 600 | 109 € |
| 670-EWEC37M06000650 | 598 a 602 | 650 | 358 € |
| 670-EWEC37M06000700 | 598 a 602 | 700 | 384 € |
| 670-EWEC37M06500650 | 648 a 652 | 650 | 118 € |
| 670-EWEC37M06500700 | 648 a 652 | 700 | 386 € |
| 670-EWEC37M06500750 | 648 a 652 | 750 | 411 € |
| 670-EWEC37M07000700 | 698 a 702 | 700 | 127 € |
| 670-EWEC37M07000750 | 698 a 702 | 750 | 413 € |
| 670-EWEC37M07000800 | 698 a 702 | 800 | 438 € |
| 670-EWEC37M07500750 | 748 a 752 | 750 | 137 € |
| 670-EWEC37M07500800 | 748 a 752 | 800 | 440 € |
| 670-EWEC37M08000800 | 798 a 802 | 800 | 146 € |



Sistema EW - ECO 304

AMPLIACIONES

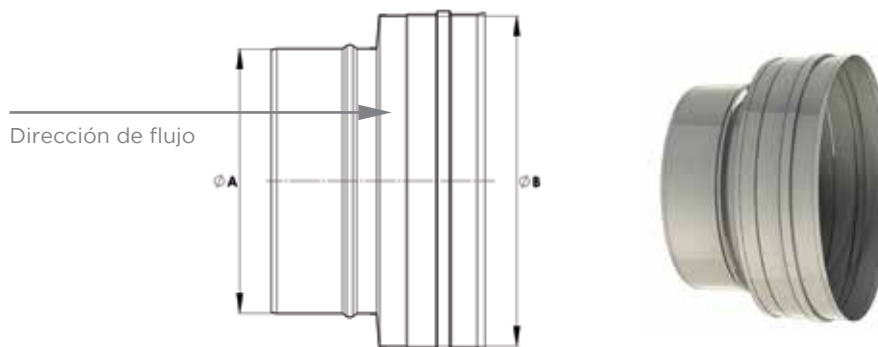

| CÓDIGO | Ø A | Ø B | € |
|-------------------|-----|-----|-------|
| 670-EWECA00800100 | 80 | 100 | 28 € |
| 670-EWECA00800130 | 80 | 130 | 41 € |
| 670-EWECA00800150 | 80 | 150 | 50 € |
| 670-EWECA00800180 | 80 | 180 | 62 € |
| 670-EWECA01000130 | 100 | 130 | 39 € |
| 670-EWECA01000150 | 100 | 150 | 48 € |
| 670-EWECA01000180 | 100 | 180 | 59 € |
| 670-EWECA01000200 | 100 | 200 | 74 € |
| 670-EWECA01300150 | 130 | 150 | 42 € |
| 670-EWECA01300180 | 130 | 180 | 54 € |
| 670-EWECA01300200 | 130 | 200 | 69 € |
| 670-EWECA01300250 | 130 | 250 | 84 € |
| 670-EWECA01300300 | 130 | 300 | 108 € |
| 670-EWECA01500180 | 150 | 180 | 49 € |
| 670-EWECA01500200 | 150 | 200 | 66 € |
| 670-EWECA01500250 | 150 | 250 | 80 € |
| 670-EWECA01500300 | 150 | 300 | 102 € |
| 670-EWECA01500350 | 150 | 350 | 124 € |
| 670-EWECA01800200 | 180 | 200 | 60 € |
| 670-EWECA01800250 | 180 | 250 | 77 € |
| 670-EWECA01800300 | 180 | 300 | 98 € |
| 670-EWECA01800350 | 180 | 350 | 119 € |
| 670-EWECA01800400 | 180 | 400 | 152 € |
| 670-EWECA02000250 | 200 | 250 | 70 € |
| 670-EWECA02000300 | 200 | 300 | 94 € |
| 670-EWECA02000350 | 200 | 350 | 114 € |
| 670-EWECA02000400 | 200 | 400 | 145 € |
| 670-EWECA02000450 | 200 | 450 | 162 € |
| 670-EWECA02500300 | 250 | 300 | 86 € |
| 670-EWECA02500350 | 250 | 350 | 110 € |
| 670-EWECA02500400 | 250 | 400 | 139 € |
| 670-EWECA02500450 | 250 | 450 | 156 € |
| 670-EWECA02500500 | 250 | 500 | 171 € |
| 670-EWECA03000350 | 300 | 350 | 99 € |
| 670-EWECA03000400 | 300 | 400 | 134 € |
| 670-EWECA03000450 | 300 | 450 | 149 € |
| 670-EWECA03000500 | 300 | 500 | 164 € |

| CÓDIGO | Ø A | Ø B | € |
|-------------------|-----|-----|-------|
| 670-EWECA03000550 | 300 | 550 | 189 € |
| 670-EWECA03500400 | 350 | 400 | 121 € |
| 670-EWECA03500450 | 350 | 450 | 142 € |
| 670-EWECA03500500 | 350 | 500 | 158 € |
| 670-EWECA03500550 | 350 | 550 | 182 € |
| 670-EWECA03500600 | 350 | 600 | 194 € |
| 670-EWECA04000450 | 400 | 450 | 130 € |
| 670-EWECA04000500 | 400 | 500 | 150 € |
| 670-EWECA04000550 | 400 | 550 | 175 € |
| 670-EWECA04000600 | 400 | 600 | 187 € |
| 670-EWECA04000650 | 400 | 650 | 207 € |
| 670-EWECA04500500 | 450 | 500 | 137 € |
| 670-EWECA04500550 | 450 | 550 | 167 € |
| 670-EWECA04500600 | 450 | 600 | 179 € |
| 670-EWECA04500650 | 450 | 650 | 199 € |
| 670-EWECA04500700 | 450 | 700 | 256 € |
| 670-EWECA05000550 | 500 | 550 | 152 € |
| 670-EWECA05000600 | 500 | 600 | 171 € |
| 670-EWECA05000650 | 500 | 650 | 190 € |
| 670-EWECA05000700 | 500 | 700 | 246 € |
| 670-EWECA05000750 | 500 | 750 | 268 € |
| 670-EWECA05500600 | 550 | 600 | 156 € |
| 670-EWECA05500650 | 550 | 650 | 182 € |
| 670-EWECA05500700 | 550 | 700 | 235 € |
| 670-EWECA05500750 | 550 | 750 | 257 € |
| 670-EWECA05500800 | 550 | 800 | 293 € |
| 670-EWECA06000650 | 600 | 650 | 165 € |
| 670-EWECA06000700 | 600 | 700 | 226 € |
| 670-EWECA06000750 | 600 | 750 | 247 € |
| 670-EWECA06000800 | 600 | 800 | 281 € |
| 670-EWECA06500700 | 650 | 700 | 205 € |
| 670-EWECA06500750 | 650 | 750 | 236 € |
| 670-EWECA06500800 | 650 | 800 | 270 € |
| 670-EWECA07000750 | 700 | 750 | 214 € |
| 670-EWECA07000800 | 700 | 800 | 257 € |
| 670-EWECA07500800 | 750 | 800 | 234 € |



REDUCCIONES

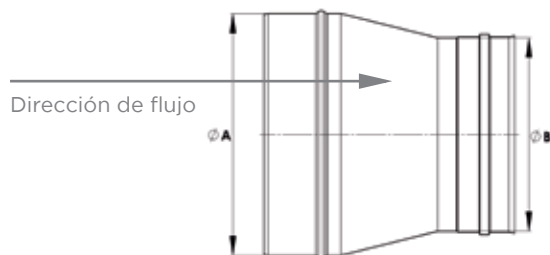

| CÓDIGO | Ø A | Ø B | € |
|-------------------|-----|-----|-------|
| 670-EWECR01000080 | 100 | 80 | 28 € |
| 670-EWECR01300080 | 130 | 80 | 41 € |
| 670-EWECR01300100 | 130 | 100 | 39 € |
| 670-EWECR01500080 | 150 | 80 | 50 € |
| 670-EWECR01500100 | 150 | 100 | 48 € |
| 670-EWECR01500130 | 150 | 130 | 42 € |
| 670-EWECR01800080 | 180 | 80 | 62 € |
| 670-EWECR01800100 | 180 | 100 | 59 € |
| 670-EWECR01800130 | 180 | 130 | 54 € |
| 670-EWECR01800150 | 180 | 150 | 49 € |
| 670-EWECR02000100 | 200 | 100 | 74 € |
| 670-EWECR02000130 | 200 | 130 | 69 € |
| 670-EWECR02000150 | 200 | 150 | 66 € |
| 670-EWECR02000180 | 200 | 180 | 60 € |
| 670-EWECR02500130 | 250 | 130 | 84 € |
| 670-EWECR02500150 | 250 | 150 | 80 € |
| 670-EWECR02500180 | 250 | 180 | 77 € |
| 670-EWECR02500200 | 250 | 200 | 70 € |
| 670-EWECR03000130 | 300 | 130 | 108 € |
| 670-EWECR03000150 | 300 | 150 | 102 € |
| 670-EWECR03000180 | 300 | 180 | 98 € |
| 670-EWECR03000200 | 300 | 200 | 94 € |
| 670-EWECR03000250 | 300 | 250 | 86 € |
| 670-EWECR03500150 | 350 | 150 | 124 € |
| 670-EWECR03500180 | 350 | 180 | 119 € |
| 670-EWECR03500200 | 350 | 200 | 114 € |
| 670-EWECR03500250 | 350 | 250 | 110 € |
| 670-EWECR03500300 | 350 | 300 | 99 € |
| 670-EWECR04000180 | 400 | 180 | 152 € |
| 670-EWECR04000200 | 400 | 200 | 145 € |
| 670-EWECR04000250 | 400 | 250 | 139 € |
| 670-EWECR04000300 | 400 | 300 | 134 € |
| 670-EWECR04000350 | 400 | 350 | 121 € |
| 670-EWECR04500200 | 450 | 200 | 162 € |
| 670-EWECR04500250 | 450 | 250 | 156 € |
| 670-EWECR04500300 | 450 | 300 | 149 € |
| 670-EWECR04500350 | 450 | 350 | 142 € |

| CÓDIGO | Ø A | Ø B | € |
|-------------------|-----|-----|-------|
| 670-EWECR04500400 | 450 | 400 | 130 € |
| 670-EWECR05000250 | 500 | 250 | 171 € |
| 670-EWECR05000300 | 500 | 300 | 164 € |
| 670-EWECR05000350 | 500 | 350 | 158 € |
| 670-EWECR05000400 | 500 | 400 | 150 € |
| 670-EWECR05000450 | 500 | 450 | 137 € |
| 670-EWECR05500300 | 550 | 300 | 189 € |
| 670-EWECR05500350 | 550 | 350 | 182 € |
| 670-EWECR05500400 | 550 | 400 | 175 € |
| 670-EWECR05500450 | 550 | 450 | 167 € |
| 670-EWECR05500500 | 550 | 500 | 152 € |
| 670-EWECR06000350 | 600 | 350 | 194 € |
| 670-EWECR06000400 | 600 | 400 | 187 € |
| 670-EWECR06000450 | 600 | 450 | 179 € |
| 670-EWECR06000500 | 600 | 500 | 171 € |
| 670-EWECR06000550 | 600 | 550 | 156 € |
| 670-EWECR06500400 | 650 | 400 | 207 € |
| 670-EWECR06500450 | 650 | 450 | 199 € |
| 670-EWECR06500500 | 650 | 500 | 190 € |
| 670-EWECR06500550 | 650 | 550 | 182 € |
| 670-EWECR06500600 | 650 | 600 | 165 € |
| 670-EWECR07000450 | 700 | 450 | 256 € |
| 670-EWECR07000500 | 700 | 500 | 246 € |
| 670-EWECR07000550 | 700 | 550 | 235 € |
| 670-EWECR07000600 | 700 | 600 | 226 € |
| 670-EWECR07000650 | 700 | 650 | 205 € |
| 670-EWECR07500500 | 750 | 500 | 268 € |
| 670-EWECR07500550 | 750 | 550 | 257 € |
| 670-EWECR07500600 | 750 | 600 | 247 € |
| 670-EWECR07500650 | 750 | 650 | 236 € |
| 670-EWECR07500700 | 750 | 700 | 214 € |
| 670-EWECR08000550 | 800 | 550 | 293 € |
| 670-EWECR08000600 | 800 | 600 | 281 € |
| 670-EWECR08000650 | 800 | 650 | 270 € |
| 670-EWECR08000700 | 800 | 700 | 257 € |
| 670-EWECR08000750 | 800 | 750 | 234 € |