

# VALVÚLAS DE MARIPOSA SANITARIAS

## VALVÚLAS DE BOLA SANITARIAS

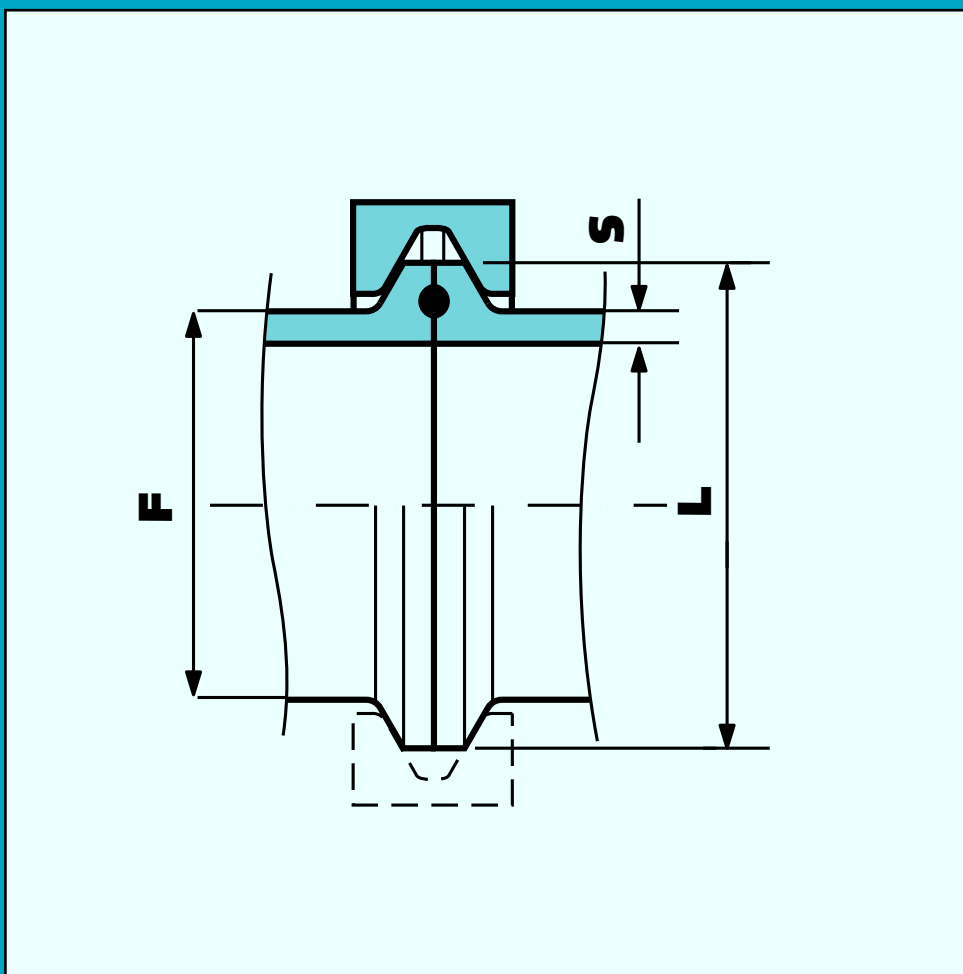

### CLAMP "BS 4825"

DN inch	L mm	F mm	S mm
1/2	25,1	12,7	1,65
3/4	25,1	19,1	1,65
1	50,4	25,4	1,65
1 1/2	50,4	38,1	1,65
2	64,0	50,8	1,65
2 1/2	77,4	63,5	1,65
3	90,9	76,1	1,65
4	118,8	101,6	2,00
5	155,0	129,0	2,50
6	167,0	154,0	3,00
8	217,0	204,0	3,00

### CLAMP "ISO 1127"

DN mm	L mm	F mm	S mm
8	34,0	13,7	2,00
10	34,0	17,2	2,00
15	34,0	21,3	2,00
20	50,4	26,9	2,00
25	50,4	33,7	2,00
32	50,4	42,4	2,00
40	64,0	48,3	2,00
50	77,4	60,3	2,00
65	90,9	76,2	2,50
80	106,0	88,9	2,50
100	130,0	114,3	3,00
125	155,0	139,7	3,00
150	183,0	168,3	3,00

# VALVULA MARIPOSA (SIN MANILLA)

VALVULA MARIPOSA SANITARIA CONEXIONES CLAMP-CLAMP

**1.100.LL. --**

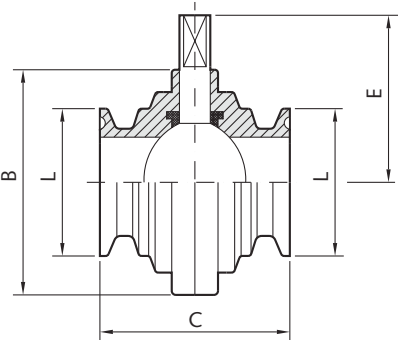

	DN inch	L mm	B mm	C mm	E mm	kg
<b>1.100.LL.03-A</b>	1/2	25,1	50	58	40	0,65
<b>1.100.LL.07-A</b>	3/4	25,1	50	58	40	0,75
<b>1.100.LL.11-A</b>	1	50,4	79	68	58	0,9
<b>1.100.LL.24-A</b>	1 1/2	50,4	85	76	63	0,10
<b>1.100.LL.44-A</b>	2	64	105	80	71	1,75
<b>1.100.LL.58-A</b>	2 1/2	77,4	113	82	76	1,90
<b>1.100.LL.70-A</b>	3	90,9	125	82	81	2,00
<b>1.100.LL.76-A</b>	4	118,8	157	88	100	3,50

VALVULA MARIPOSA SANITARIA CONEXIONES SOLDAR-SOLDAR

**1.100.MM. --**

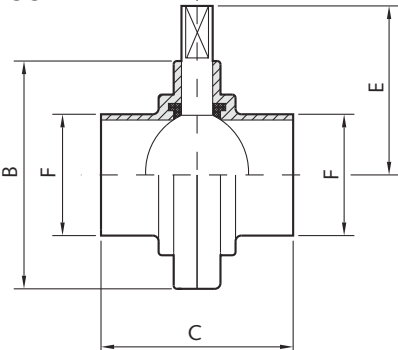

	DN inch	F mm	B mm	C mm	E mm	kg
<b>1.100.MM.03-A</b>	1/2	12,7	50	58	40	0,55
<b>1.100.MM.07-A</b>	3/4	19,1	50	58	40	0,60
<b>1.100.MM.11-A</b>	1	25,4	79	68	58	0,77
<b>1.100.MM.24-A</b>	1 1/2	38,1	85	76	63	0,85
<b>1.100.MM.44-A</b>	2	50,8	105	80	71	1,40
<b>1.100.MM.58-A</b>	2 1/2	63,5	113	82	76	1,50
<b>1.100.MM.70-A</b>	3	76,1	125	82	81	1,75
<b>1.100.MM.76-A</b>	4	101,6	157	88	100	2,70

VALVULA MARIPOSA SANITARIA CONEXIONES SOLDAR-CLAMP

**1.100.ML. --**

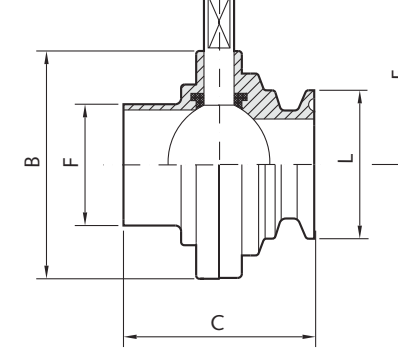

	DN inch	L mm	F mm	B mm	C mm	E mm	kg
<b>1.100.ML.03-A</b>	1/2	12,7	25,1	50	58	40	0,60
<b>1.100.ML.07-A</b>	3/4	19,1	25,1	50	58	40	0,70
<b>1.100.ML.11-A</b>	1	25,4	50,4	79	68	58	0,83
<b>1.100.ML.24-A</b>	1 1/2	38,1	50,4	85	76	63	1,00
<b>1.100.ML.44-A</b>	2	50,8	64	105	80	71	1,60
<b>1.100.ML.58-A</b>	2 1/2	63,5	77,4	113	82	76	1,70
<b>1.100.ML.70-A</b>	3	76,1	90,9	125	82	81	1,90
<b>1.100.ML.76-A</b>	4	101,6	118,8	157	88	100	3,10

CLAMP "BS"



93 699 46 04



pedidos@suministrosrado.com www.suministrosrado.com

# VALVULA DE BOLA 2VIAS CON PALANCA "CLASSIC"

**CLAMP "BS"**

## VALVULA DE BOLA "CLASSIC" CONEXIONES CLAMP-CLAMP

2.100.LL. --	DN inch	L mm	A mm	B mm	C mm	D mm	E mm	kg
2.100.LL.03-A	1/2	25,1	10	28	64	75	58	0,30
2.100.LL.07-A	3/4	25,1	15	35	78	82	67	0,40
2.100.LL.11-A	1	50,4	25	50	88	98	75	1,00
2.100.LL.24-A	1 1/2	50,4	36	62	96	120	101	1,60
2.100.LL.44-A	2	64	45	78	110	153	120	2,60
2.100.LL.58-A	2 1/2	77,4	57	100	134	153	130	4,20
2.100.LL.70-A	3	90,9	66	114	157	190	158	6,80
2.100.LL.76-A	4	118,8	98,5	160	186	248	230	14,70

## VALVULA DE BOLA "CLASSIC" CONEXIONES SOLDAR-SOLDAR

2.100.MM. --	DN inch	F mm	A mm	B mm	C mm	D mm	E mm	kg
2.100.MM.03-A	1/2	12,7	10	28	64	75	58	0,30
2.100.MM.07-A	3/4	19,1	15	35	78	82	67	0,40
2.100.MM.11-A	1	25,4	25	50	88	98	75	0,80
2.100.MM.24-A	1 1/2	38,1	36	62	104	120	101	1,50
2.100.MM.44-A	2	50,8	45	78	115	153	120	2,50
2.100.MM.58-A	2 1/2	63,5	57	100	138	153	130	4,10
2.100.MM.70-A	3	76,1	66	114	165	190	158	6,20
2.100.MM.76-A	4	101,6	98,5	160	197	248	230	13,30

## VALVULA DE BOLA "CLASSIC" CONEXIONES SOLDAR-CLAMP

2.100.ML. --	DN inch	L mm	F mm	A mm	B mm	C mm	E mm	kg
2.100.ML.03-A	1/2	25,1	12,7	10	28	64	58	0,30
2.100.ML.07-A	3/4	25,1	19,1	15	35	78	67	0,40
2.100.ML.11-A	1	50,4	25,4	25	50	88	75	0,90
2.100.ML.24-A	1 1/2	50,4	38,1	36	62	100	101	1,55
2.100.ML.44-A	2	64	50,8	45	78	110	120	2,55
2.100.ML.58-A	2 1/2	77,4	63,5	57	100	136	130	4,15
2.100.ML.70-A	3	90,9	76,1	66	114	161	158	6,35
2.100.ML.76-A	4	118,8	101,6	98,5	160	193	230	13,80



93 699 46 04



pedidos@suministrosrado.com www.suministrosrado.com

# VALVULA BOLA SANITARIA 2 VIAS CON PALANCA "STAR"

**CLAMP "BS"**

## VALVULA DE BOLA "STAR" CONEXIONES CLAMP-CLAMP

**2.200.LL. --**

	DN	L	A	B	C	D	E	
	inch	mm	mm	mm	mm	mm	mm	kg
<b>2.200.LL.11-A</b>	1	50,4	25	57	71	98	75	1,13
<b>2.200.LL.24-A</b>	1 1/2	50,4	36	75	90	120	101	1,50
<b>2.200.LL.44-A</b>	2	64	45	91	104	153	120	2,90
<b>2.200.LL.58-A</b>	2 1/2	77,4	57	111	124	153	130	4,70
<b>2.200.LL.70-A</b>	3	90,9	66	126	143	190	158	6,80
<b>2.200.LL.76-A</b>	4	118,8	98,5	172	179	248	230	13,70

## VALVULA DE BOLA "STAR" CONEXIONES SOLDAR-SOLDAR

**2.200.MM. --**

	DN	F	A	B	C	D	E	
	inch	mm	mm	mm	mm	mm	mm	kg
<b>2.200.MM.11-A</b>	1	25,4	25	57	73	98	75	1,10
<b>2.200.MM.24-A</b>	1 1/2	38,1	36	75	94	120	101	1,40
<b>2.200.MM.44-A</b>	2	50,8	45	91	108	153	120	2,70
<b>2.200.MM.58-A</b>	2 1/2	63,5	57	111	128	153	130	4,35
<b>2.200.MM.70-A</b>	3	76,1	66	126	147	190	158	6,40
<b>2.200.MM.76-A</b>	4	76,1	98,5	172	185	248	230	13,50

## VALVULA DE BOLA "STAR" CONEXIONES SOLDAR-CLAMP

**2.200.ML. --**

	DN	L	F	A	B	C	E	
	inch	mm	mm	mm	mm	mm	mm	kg
<b>2.100.ML.11-A</b>	1	50,4	25,4	25	57	72	75	1,10
<b>2.100.ML.24-A</b>	1 1/2	50,4	38,1	36	75	92	101	1,45
<b>2.100.ML.44-A</b>	2	64	50,8	45	91	106	120	2,80
<b>2.100.ML.58-A</b>	2 1/2	77,4	63,5	57	111	126	130	4,50
<b>2.100.ML.70-A</b>	3	90,9	76,1	66	126	145	158	6,60
<b>2.100.ML.76-A</b>	4	118,8	101,6	98,5	172	182	230	13,60



93 699 46 04



pedidos@suministrosrado.com www.suministrosrado.com

# VALVULA DE BOLA TRES VIAS CLAMP

## VALVULA DE BOLA TRES VIAS EN "L" CONEXIONES CLAMP

**2.320.LL. --**

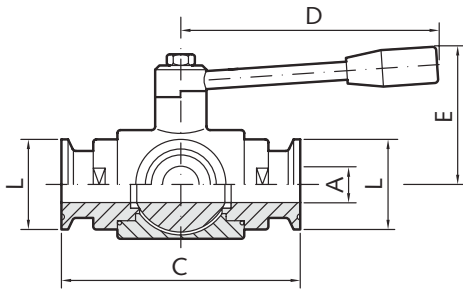

	DN inch	L mm	A mm	C mm	D mm	E mm	PN mm	kg
<b>2.320.LL.03-C</b>	1/2	25,1	10	108	110	60	40	1,10
<b>2.320.LL.07-C</b>	3/4	25,1	15	118	110	65	40	1,30
<b>2.320.LL.10-C</b>	1	50,4	20	130	160	70	40	2,45
<b>2.320.LL.11-C</b>	1	50,4	25	140	160	80	40	3,10
<b>2.320.LL.23-C</b>	1 1/2	50,4	32	156	190	95	40	5,00
<b>2.320.LL.24-C</b>	1 1/2	50,4	40	172	190	110	40	7,40
<b>2.320.LL.44-C</b>	2	64	50	182	235	120	25	8,60
<b>2.320.LL.58-C</b>	2 1/2	77,4	65	196	285	130	25	10,70
<b>2.320.LL.70-C</b>	3	90,9	80	256	310	145	16	22,10
<b>2.320.LL.76-C</b>	4	118,8	100	286	310	160	16	35,00

## VALVULA DE BOLA TRES VIAS EN "T" CONEXIONES CLAMP

**2.330.LL. --**

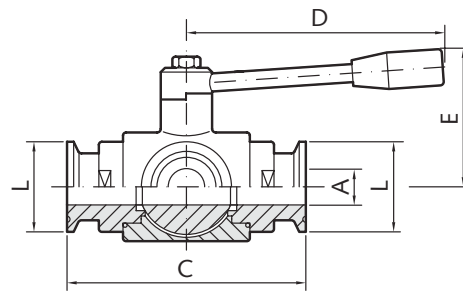

	DN inch	L mm	A mm	C mm	D mm	E mm	PN mm	kg
<b>2.330.LL.03-C</b>	1/2	25,1	10	108	110	60	40	1,10
<b>2.330.LL.07-C</b>	3/4	25,1	15	118	110	65	40	1,30
<b>2.330.LL.10-C</b>	1	50,4	20	130	160	70	40	2,45
<b>2.330.LL.11-C</b>	1	50,4	25	140	160	80	40	3,10
<b>2.330.LL.23-C</b>	1 1/2	50,4	32	156	190	95	40	5,00
<b>2.330.LL.24-C</b>	1 1/2	50,4	40	172	190	110	40	7,40
<b>2.330.LL.44-C</b>	2	64	50	182	235	120	25	8,60
<b>2.330.LL.58-C</b>	2 1/2	77,4	65	196	285	130	25	10,70
<b>2.330.LL.70-C</b>	3	90,9	80	256	310	145	16	22,10
<b>2.330.LL.76-C</b>	4	118,8	100	286	310	160	16	35,00

SFERA "L"

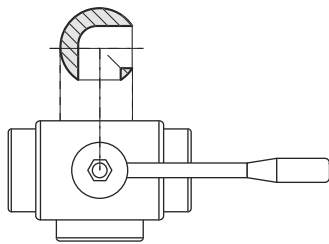

SFERA "T"

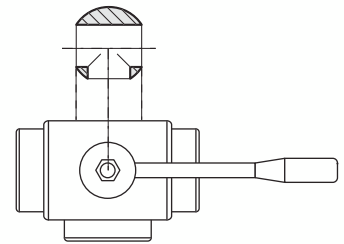

1



2



3



4



93 699 46 04



pedidos@suministrosrado.com www.suministrosrado.com