



## SERIE CORTA: MANGO DE 6 x 40 mm.

	Y501	Y508	Y510	Y505	Y504	Y551	Y556	Y552	Y554	Y553
Ø mm.	6 x 20	8 x 30	10 x 30	12 x 30	15 x 30	4,5	6	8	10	12
€	13,27	18,34	18,81	18,81	21,60	13,27	13,27	18,34	18,34	18,34
Uds.	5	5	5	5	5	5	5	5	5	5

## SERIE LARGA: MANGO DE 6 x 100 mm.

	Y501L	Y508L	Y510L	Y505L	Y504L	Y551L	Y556L	Y552L	Y554L	Y553L
Ø mm.	6 x 20	8 x 30	10 x 30	12 x 30	15 x 30	4,5	6	8	10	12
€	17,25	23,88	24,59	24,59	28,34	17,25	17,25	23,88	23,88	23,88
Uds.	5	5	5	5	5	5	5	5	5	5

\* Dentados disponibles: N° 2 APLICACION: ACEROS FINOS HASTA 80 kg./mm<sup>2</sup>  
 N° 0 APLICACION: ALEACIONES LIGERAS (exclusivamente en las medidas más usuales).



## SERIE CORTA: MANGO DE 6 x 40 mm.

	Y557	Y502	Y507	Y509	Y511	Y506	Y514	Y571	Y561	Y566
Ø mm.	15	6 x 20	8 x 20	10 x 20	10 x 30	12 x 30	15 x 30	6 x 20	6 x 20	12 x 30
€	21,60	13,27	18,34	18,34	18,81	18,81	21,60	13,27	13,27	18,81
Uds.	5	5	5	5	5	5	5	5	5	5

## SERIE LARGA: MANGO DE 6 x 100 mm.

	Y557L	Y502L	Y507L	Y509L	Y511L	Y506L	Y514L	Y571L	Y561L	Y566L
Ø mm.	15	6 x 20	8 x 20	10 x 20	10 x 30	12 x 30	15 x 30	6 x 20	6 x 20	12 x 30
€	28,34	17,25	23,88	23,88	24,61	24,61	28,34	17,25	17,25	24,59
Uds.	5	5	5	5	5	5	5	5	5	5

## FRESAS ROTATIVAS HSS

Fresas Rotativas

Rosa



SERIE CORTA: MANGO DE 6 x 40 mm.

	Y521	Y532	Y533	Y534	Y536	Y537	Y524	Y525	Y526	Y527
Ø mm.	6 x 20	6 x 15	10 x 15	10 x 17	12 x 30	15 x 35	10 x 30	12 x 20	12 x 30	15 x 30
€	13,27	13,27	18,35	18,35	18,81	21,60	18,81	18,35	18,81	21,60
Uds.	5	5	5	5	5	5	5	5	5	5

SERIE LARGA: MANGO DE 6 x 100 mm.

	Y521L	Y532L	Y533L	Y534L	Y536L	Y537L	Y524L	Y525L	Y526L	Y527L
Ø mm.	6 x 20	6 x 15	10 x 15	10 x 17	12 x 30	15 x 35	10 x 30	12 x 20	12 x 30	15 x 30
€	17,25	17,25	23,88	23,88	24,59	28,34	24,61	23,88	24,61	28,34
Uds.	5	5	5	5	5	5	5	5	5	5



SERIE CORTA: MANGO DE 6 x 40 mm.

	Y541	Y512	Y545	Y543	Y513	Y503	Y515	Y516	Y547
Ø mm.	6 x 10	12 x 12	12 x 20	12 x 20	12 x 15	10 x 15	12 x 30	12 x 30	15 x 30
€	13,27	18,35	18,35	18,35	18,35	18,35	18,81	18,81	21,60
Uds.	5	5	5	5	5	5	5	5	5

SERIE LARGA: MANGO DE 6 x 100 mm.

	Y541L	Y512L	Y545L	Y543L	Y513L	Y503L	Y515L	Y516L	Y547L
Ø mm.	6 x 10	12 x 12	12 x 20	12 x 20	12 x 15	10 x 15	12 x 30	12 x 30	15 x 30
€	17,25	23,88	23,88	23,88	23,88	23,88	24,59	24,59	28,34
Uds.	5	5	5	5	5	5	5	5	5





SERIE CORTA: MANGO DE 6 x 40 mm.

	Y255	Y256	Y258	Y259	Y260	Y261	Y264	Y265	Y266	Y272
Ø mm.	6	6 x 4	6 x 1	6 x 4	6 x 1	6	6 x 1	6	6	6
€	14,00	14,00	14,00	14,00	14,00	14,00	14,00	14,00	14,00	14,00
Uds.	5	5	5	5	5	5	5	5	5	5

## FRESAS ROTATIVAS PARA GRABADORES HSS



MANGO DE 3 x 30 mm.

	Y055	Y056	Y057	Y058	Y059	Y060	Y061	Y062	Y063
Ø mm.	7	7 x 4	7 x 3	7 x 1	7 x 4	7 x 1	7	7	7 x 4
€	14,00	14,00	14,00	14,00	14,00	14,00	14,00	14,00	14,00
Uds.	5	5	5	5	5	5	5	5	5



REFERENCIA	<b>E70SR</b>							<b>EF58SR</b>		<b>E33SR</b>	
Nº FRESAS	70							58		33	
CALIDAD	<b>HSS</b>							<b>HSS</b>		<b>HSS</b>	
CONTENIDO	<u>Y504</u>	<u>Y537</u>	<u>Y526</u>	<u>Y505</u>	<u>Y506</u>	<u>Y510</u>	<u>Y536</u>	1 Fresa de cada tipo	Y502 - Y501 - Y541 - Y532 - Y521 - Y571 - Y561 Y551 - Y556 - Y507 - Y512 - Y533 Y534 - Y552 Y554 - Y553 - Y557 - Y509 - Y513 - Y525 - Y545 Y524 - Y515 - Y536 - Y526 - Y537 - Y547 - Y527 Y504 - Y566 - Y516 - Y505 - Y506		
Cantidad	5	5	5	5	5	5	5				
	<u>Y553</u>	<u>Y525</u>	<u>Y534</u>	<u>Y552</u>	<u>Y502</u>	<u>Y532</u>	<u>Y501</u>				
	5	5	5	5	5	5	5				
P.V.P. €	<b>1.250,04</b>							<b>971,08</b>		<b>594,34</b>	

### VELOCIDADES DE CORTE RECOMENDADAS PARA FRESAS ROTATIVAS HSS

Ø mm.	ACERO	ACERO TEMPLADO	INOX	FUNDICIÓN ALUMINIO	ALUMINIO	TITANIO	PLÁSTICO	LATÓN
2	20.000	-	-	20.000	25.000	-	21.000	25.000
3	18.000	-	-	20.000	25.000	-	21.000	25.000
4	16.000	-	-	20.000	25.000	-	21.000	25.000
5	14.000	-	-	20.000	25.000	-	21.000	25.000
6	12.000	-	-	20.000	25.000	-	21.000	25.000
8	10.000	-	-	16.000	21.000	-	14.000	21.000
9	10.000	-	-	16.000	21.000	-	14.000	21.000
10	8.000	-	-	16.000	21.000	-	14.000	21.000
11	6.000	-	-	16.000	21.000	-	14.000	21.000
12	5.000	-	-	16.000	21.000	-	14.000	21.000
14	5.000	-	-	16.000	21.000	-	14.000	21.000
18	5.000	-	-	12.000	17.000	-	9.000	17.000
20	4.500	-	-	12.000	17.000	-	9.000	17.000
22	4.500	-	-	12.000	17.000	-	9.000	17.000
25	4.000	-	-	10.000	15.000	-	9.000	15.000

## Tipos de dentados Standard



**Dentado 2** - Dentado standard para uso general



**Dentado 3** - Trabajo rápido con gran arranque de material en materiales no férricos y plásticos. Aluminio.



**Dentado 6** - Dentado cruzado para usos generales, obteniendo buen control y viruta corta. ¡ El dentado más usual !

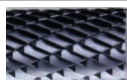

**Dentado 6+TiAlN** - Dentado cruzado para usos generales con TiAlN

## Tipos de dentados Especiales



**Dentado 1** - Desbaste y acabado en aleaciones de materiales no ferrosos.



**Dentado 4** - Dentado fino para buen acabado



**Dentado 5** - Dentado para gran desbaste. Usos generales.

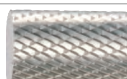

**Dentado 8** - Dentado diamante para materiales más duros proporcionando mejor acabado.

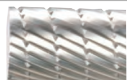

**Dentado 9** - Dentado con rompe-virutas. Aumenta el control y mejora el acabado



**Dentado 10** - Dentado con rompe-virutas gran desbaste. Construcción naval.

## Guía de selección de dentado

Material	1	2	3	4	5	6	6 TiAlN	7	8	9	10
Aluminio			●								●
Acero al carbono		●				●	●	●		●	
Plástico	●										
Latón, Cobre, Bronce	●		●								●
Hierro fundido		●			●	●	●			●	
Aleación de Magnesio				●							
Aceros		●		●		●	●		●	●	
Acero Inoxidable		●				●	●				
Aceros de fundición		●			●	●	●	●		●	
Soldaduras		●				●	●	●		●	
Plásticos reforzados	●		●								●
Goma dura	●			●							
Aleaciones de Titanio		●				●	●				
Aleaciones de Zinc		●		●							
Fibra de Vidrio		●	●			●	●				●

## Tabla de velocidades recomendadas

Velocidad de la fresa x 1.000 rpm

Diámetro Fresas	1	2	3	4	5	6	6 TiAlN	7	8	9	10
3mm - 1/8"	35-70	50-100		35-70		50-100	65-105		50-100	50-100	
4mm - 5/32"	35-70	50-80		35-70		50-80	55-90		50-80	50-80	
5mm - 3/16"	25-60	30-60		25-45		30-60	40-70		30-60	30-60	
6mm - 1/4"	25-60	30-60	25-60	25-45		30-60	40-70		30-60	30-60	25-60
8mm - 5/16"	25-40	25-55	25-55	25-40	25-55	25-55	30-60		25-55	25-55	25-55
10mm - 3/8"	20-30	20-40	20-30	20-40	20-40	20-40	25-45	20-40	20-40	20-40	20-30
12mm - 1/2"	10-25	15-35	10-25	15-35	15-35	15-35	20-40	15-35	15-35	15-35	10-25
15mm - 5/8"	10-25	10-35	10-25	10-30	10-30	10-30	15-35	10-30	10-30	10-30	10-25
20mm - 3/4"	10-20	6-25	10-20	10-20	6-25	6-25	9-30		6-25	6-25	10-20
25mm - 1"	6-20	6-20		6-20		6-20	9-25		6-20	6-20	

Las velocidades recomendadas están basadas en longitudes standard de mangos de 45 mm., con un máximo saliente de 10 mm. El máximo de velocidad recomendada en fresos extralargos es de 15.000 RPM

## Selección de la fresa rotativa PROCUT

**PASO 1**

Identificar el tipo de fresa rotativa dependiendo de la aplicación.



Tipo: C

**PASO 2**

Seleccionar el diámetro sin olvidar, que no más del 50% del diámetro de los dientes han de estar en contacto con el material.

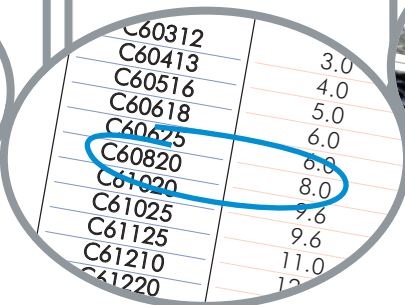

**PASO 3**

Seleccionar el dentado correcto según material a trabajar.



**PASO 4**

Asegúrese que la fresa trabaja a la velocidad recomendada. Los errores, pueden causar una reducción de productividad y un riesgo en su seguridad.



## Identificación de referencias

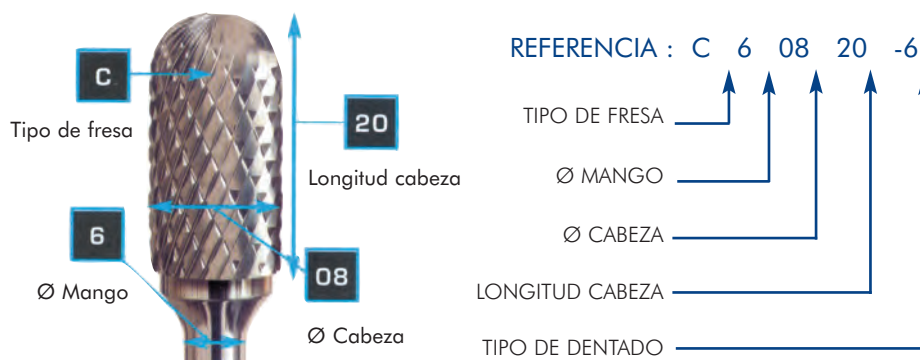

# CILÍNDRICA SIN CORTE FRONTAL

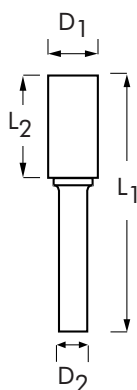
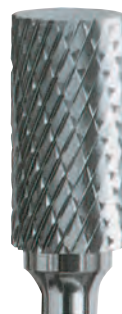
**TIPO  
A**

**TiAlN**

**3 mm. MANGO**

Referencia	Dimensiones - En mm				Tipo
	D <sub>1</sub>	L <sub>2</sub>	D <sub>2</sub>	L <sub>1</sub>	
A30106	1.5	6.0	3	38	Monobloc
A30211	2.0	11.0	3	38	Monobloc
A30212	2.5	12.0	3	38	Monobloc
A30314	3.0	14.0	3	38	Monobloc
A30512	5.0	12.7	3	38	Monobloc
A30605	6.3	4.7	3	37	Soldada
A30612	6.3	12.7	3	45	Soldada
<b>SERIE LARGA</b>					
A30314-50	3.0	14.0	3	50	Monobloc
A30314-75	3.0	14.0	3	75	Monobloc
A30314-100	3.0	14.0	3	100	Monobloc

**6 mm. MANGO**

Referencia	Dimensiones - En mm				Tipo
	D <sub>1</sub>	L <sub>2</sub>	D <sub>2</sub>	L <sub>1</sub>	
A60312	3.0	14.0	6	50	Monobloc
A60413	4.0	14.0	6	50	Monobloc
A60516	5.0	16.0	6	50	Monobloc
A60618	6.0	18.0	6	50	Monobloc
A60625	6.0	25.0	6	50	Monobloc
A60820	8.0	19.0	6	64	Soldada
A61014	9.6	13.5	6	59	Soldada
A61020	9.6	19.0	6	64	Soldada
A61025	9.6	25.0	6	70	Soldada
A61125	11.0	25.0	6	70	Soldada
A61220	12.7	19.0	6	64	Soldada
A61225	12.7	25.0	6	70	Soldada
A61525	16.0	25.0	6	70	Soldada
A62025	19.0	25.0	6	70	Soldada
A62525	25.0	25.0	6	70	Soldada
<b>SERIE LARGA</b>					
A60618-100	6.0	18.0	6	100	Monobloc
A60618-150	6.0	18.0	6	150	Monobloc
A60820-170	8.0	19.0	6	172	Soldada
A61020-170	9.6	19.0	6	172	Soldada
A61225-175	12.7	25.0	6	178	Soldada

**8 mm. MANGO**

Referencia	Dimensiones - En mm				Tipo
	D <sub>1</sub>	L <sub>2</sub>	D <sub>2</sub>	L <sub>1</sub>	
A81225	12.7	25.0	8	70	Soldada
A81525	16.0	25.0	8	70	Soldada
A82025	19.0	25.0	8	70	Soldada
A82525	25.0	25.0	8	70	Soldada





## CILÍNDRICA SIN CORTE FRONTAL



EN STOCK: Exclusivamente los diámetros y dentados tarifados.

Los diámetros y dentados punteados no se encuentran en stock, pero se pueden suministrar bajo demanda con los siguientes recargos:

- Dentados 1, 4 y 5 recargo 10% sobre tarifa dentado n°6
- Dentado 7, 8, 9 y 10 recargo 20% sobre tarifa dentado n°6

Los diámetros y dentados cuyas casillas figuren en blanco (sin precios y sin punteo) se suministran con oferta previa de precio y plazo.

Referencia	Dentados - P.V.P.										
	1	2	3	4	5	6	6+TiAlN	7	8	9	10
A30106		15,32				15,32	21,90				
A30211		13,43		√		13,43	19,77		√	√	
A30212		12,02				12,02	19,29				
A30314		9,71	20,20	√		9,85	17,03		√	√	
A30512		26,38				26,38	39,91				
A30605		17,92		√		17,92	27,05		√	√	
A30612		15,97	27,43	√		16,59	28,38		√	√	
A30314-50		22,86	31,99	√		22,86	√		√	√	
A30314-75		28,27	39,56	√		28,53	√		√	√	
A30314-100		32,83	45,97	√		32,83	√		√	√	

Referencia	Dentados - P.V.P.										
	1	2	3	4	5	6	6+TiAlN	7	8	9	10
A60312		26,99				26,99	38,78				
A60413		24,73				24,73	36,51				
A60516		20,48				21,27	34,15				
A60618	√	19,82	26,77	√		19,26	30,25		√	√	√
A60625		27,66				27,66	44,41				
A60820	√	24,27	30,05	√		24,50	37,54		√	√	√
A61014		28,72				28,72	38,85				
A61020	√	27,43	30,50	√	31,63	27,70	43,56	√	√	√	√
A61025		31,77				31,77	45,57				
A61125		37,41		√		37,41	54,62		√	√	
A61220		42,97		√		41,36	61,58		√	√	
A61225	√	38,51	45,39	√	44,44	39,26	59,50	√	√	√	√
A61525	√	48,46	62,96	√	55,91	49,40	73,24	√	√	√	√
A62025		85,45	94,62	√		85,45	111,42		√	√	√
A62525		124,49	156,71	√		124,49	155,82		√	√	
A60618-100		57,76	80,87			57,76	√		√	√	
A60618-150		74,40	104,14			74,40	√		√	√	
A60820-170		32,67	48,03			32,67	√		√	√	
A61020-170		37,34	51,69			35,95	√		√	√	
A61225-175		58,29	80,87			58,29	√		√	√	

Referencia	Dentados - P.V.P.										
	1	2	3	4	5	6	6+TiAlN	7	8	9	10
A81225	√	40,01	47,62	√	44,44	40,01	59,50	√	√	√	√
A81525	√	50,34	62,96	√		50,34	73,24	√	√	√	√
A82025		85,45	94,62	√		85,45	111,42		√	√	√
A82525		124,49	156,71	√		124,49	155,82		√	√	

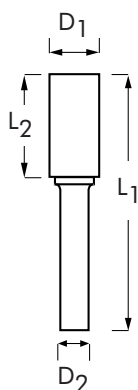

**TIPO  
A/E**

**TiAlN**

**3 mm. MANGO**

Referencia	Dimensiones - En mm				Tipo
	D <sub>1</sub>	L <sub>2</sub>	D <sub>2</sub>	L <sub>1</sub>	
A30106E	1.5	6.0	3	38	Monobloc
A30211E	2.0	11.0	3	38	Monobloc
A30212E	2.5	12.0	3	38	Monobloc
A30314E	3.0	14.0	3	38	Monobloc
A30512E	5.0	12.7	3	38	Monobloc
A30605E	6.3	4.7	3	37	Soldada
A30612E	6.3	12.7	3	45	Soldada
<b>SERIE LARGA</b>					
A30314-50E	3.0	14.0	3	50	Monobloc
A30314-75E	3.0	14.0	3	75	Monobloc
A30314-100E	3.0	14.0	3	100	Monobloc

**6 mm. MANGO**

Referencia	Dimensiones - En mm				Tipo
	D <sub>1</sub>	L <sub>2</sub>	D <sub>2</sub>	L <sub>1</sub>	
A60312E	3.0	14.0	6	50	Monobloc
A60413E	4.0	14.0	6	50	Monobloc
A60516E	5.0	16.0	6	50	Monobloc
A60618E	6.0	18.0	6	50	Monobloc
A60625E	6.0	25.0	6	50	Monobloc
A60820E	8.0	19.0	6	64	Soldada
A61014E	9.6	13.5	6	59	Soldada
A61020E	9.6	19.0	6	64	Soldada
A61025E	9.6	25.0	6	70	Soldada
A61125E	11.0	25.0	6	70	Soldada
A61220E	12.7	19.0	6	64	Soldada
A61225E	12.7	25.0	6	70	Soldada
A61525E	16.0	25.0	6	70	Soldada
A62025E	19.0	25.0	6	70	Soldada
A62525E	25.0	25.0	6	70	Soldada
<b>SERIE LARGA</b>					
A60618-100E	6.0	18.0	6	100	Monobloc
A60618-150E	6.0	18.0	6	150	Monobloc
A60820-170E	8.0	19.2	6	170	Soldada
A61020-170E	9.6	19.2	6	170	Soldada
A61225-175E	12.5	25.4	6	175	Soldada

**8 mm. MANGO**

Referencia	Dimensiones - En mm				Tipo
	D <sub>1</sub>	L <sub>2</sub>	D <sub>2</sub>	L <sub>1</sub>	
A81225E	12.7	25.0	8	70	Soldada
A81525E	16.0	25.0	8	70	Soldada
A82025E	19.0	25.0	8	70	Soldada
A82525E	25.0	25.0	8	70	Soldada



EN STOCK: Exclusivamente los diámetros y dentados tarifados.

Los diámetros y dentados punteados no se encuentran en stock, pero se pueden suministrar bajo demanda con los siguientes recargos:

- Dentados 1, 4 y 5 recargo 10% sobre tarifa dentado n°6
- Dentado 7, 8, 9 y 10 recargo 20% sobre tarifa dentado n°6



Los diámetros y dentados cuyas casillas figuren en blanco (sin precios y sin punteo) se suministran con oferta previa de precio y plazo.

Referencia	Dentados - P.V.P.										
	1	2	3	4	5	6	6+TiAlN	7	8	9	10
A30106E		15,32				15,32	21,90				
A30211E		13,43		√		13,43	19,77		√	√	
A30212E		12,02				12,02	19,29				
A30314E		10,20	20,20	√		10,49	17,03		√	√	
A30512E		27,51				27,51	39,91				
A30605E		17,92		√		17,92	27,05		√	√	
A30612E		17,75	27,43	√		17,75	28,38		√	√	
A30314-50E		25,15		√		25,15	√		√	√	
A30314-75E		31,08		√		31,08	√		√	√	
A30314-100E		36,11		√		36,11	√		√	√	

Referencia	Dentados - P.V.P.										
	1	2	3	4	5	6	6+TiAlN	7	8	9	10
A60312E		26,99				26,99	38,78				
A60413E		24,73				24,73	36,51				
A60516E		21,49				22,11	34,15				
A60618E	√	19,63	29,46	√		19,63	30,25		√	√	√
A60625E		28,57				28,57	44,41				
A60820E	√	25,45	33,08	√		25,94	37,54		√	√	√
A61014E		28,76				28,76	38,85				
A61020E	√	28,76	34,89	√	31,63	29,31	43,56	√	√	√	√
A61025E		34,02				34,02	45,57				
A61125E		37,41		√		37,41	54,62		√	√	
A61220E		43,80		√		43,80	61,58		√	√	
A61225E	√	40,38	50,46	√	44,44	41,15	59,50	√	√	√	√
A61525E	√	51,78	70,62	√	55,91	49,84	73,24	√	√	√	√
A62025E		85,45	104,08	√		85,45	111,42		√	√	√
A62525E		137,91	180,08	√		137,91	169,24		√	√	
A60618-100E		63,54				63,54	∅		√	√	
A60618-150E		81,82				81,82	∅		√	√	
A60820-170E		35,93				35,93	∅		√	√	
A61020-170E		41,08				41,08	∅		√	√	
A61225-175E		64,13				64,13	∅		√	√	

Referencia	Dentados - P.V.P.										
	1	2	3	4	5	6	6+TiAlN	7	8	9	10
A81225E	√	41,15	52,42	√	44,44	41,15	59,50	√	√	√	√
A81525E	√	51,78	70,62	√		51,78	73,24	√	√	√	√
A82025E		85,45	104,08	√		85,45	111,42		√	√	√
A82525E		137,91	180,08	√		137,91	169,24		√	√	

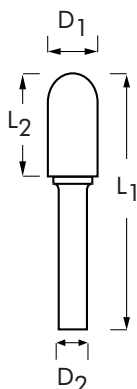

**TIPO**  
**C**

**TAIN**

3 mm. MANGO

Referencia	Dimensiones - En mm				
	D <sub>1</sub>	L <sub>2</sub>	D <sub>2</sub>	L <sub>1</sub>	Tipo
C30211	2.0	11.0	3	38	Monobloc
C30212	2.5	11.0	3	38	Monobloc
C30312	3.0	14.0	3	38	Monobloc
C30512	5.0	12.7	3	38	Monobloc
C30612	6.3	12.7	3	45	Soldada
<b>SERIE LARGA</b>					
C30312-50	3.0	14.0	3	50	Monobloc
C30312-75	3.0	14.0	3	75	Monobloc
C30312-100	3.0	14.0	3	100	Monobloc

6 mm. MANGO

Referencia	Dimensiones - En mm				
	D <sub>1</sub>	L <sub>2</sub>	D <sub>2</sub>	L <sub>1</sub>	Tipo
C60312	3.0	14.0	6	50	Monobloc
C60413	4.0	14.0	6	50	Monobloc
C60516	5.0	16.0	6	50	Monobloc
C60618	6.0	18.0	6	50	Monobloc
C60625	6.0	25.0	6	50	Monobloc
C60820	8.0	19.0	6	64	Soldada
C61020	9.6	19.0	6	64	Soldada
C61025	9.6	25.0	6	70	Soldada
C61125	11.0	25.0	6	70	Soldada
C61210	12.0	10.0	6	54	Soldada
C61220	12.7	19.0	6	64	Soldada
C61225	12.7	25.0	6	70	Soldada
C61525	16.0	25.0	6	70	Soldada
C62025	19.0	25.0	6	70	Soldada
C62525	25.0	25.0	6	70	Soldada
<b>SERIE LARGA</b>					
C60618-100	6.0	18.0	6	100	Monobloc
C60618-150	6.0	18.0	6	150	Monobloc
C60820-170	8.0	19.2	6	175	Soldada
C61020-170	9.6	19.2	6	170	Soldada
C61225-175	12.5	25.4	6	175	Soldada

8 mm. MANGO

Referencia	Dimensiones - En mm				
	D <sub>1</sub>	L <sub>2</sub>	D <sub>2</sub>	L <sub>1</sub>	Tipo
C81225	12.7	25.0	8	70	Soldada
C81525	16.0	25.0	8	70	Soldada
C82025	19.0	25.0	8	70	Soldada
C82525	25.0	25.0	8	70	Soldada







EN STOCK: Exclusivamente los diámetros y dentados tarifados.

Los diámetros y dentados punteados no se encuentran en stock, pero se pueden suministrar bajo demanda con los siguientes recargos:

- Dentados 1, 4 y 5 recargo 10% sobre tarifa dentado n°6
- Dentado 7, 8, 9 y 10 recargo 20% sobre tarifa dentado n°6

Los diámetros y dentados cuyas casillas figuren en blanco (sin precios y sin punteo) se suministran con oferta previa de precio y plazo.

Referencia	Dentados - P.V.P.										
	1	2	3	4	5	6	6+TiAlN	7	8	9	10
C30211		11,70		√		11,70	18,03		√	√	
C30212		11,70				11,70	18,03				
C30312		11,80	19,17	√		11,36	18,03		√	√	
C30512		25,87				25,87	40,71				
C30612		17,75	26,22	√		17,75	28,38		√	√	
C30312-50		26,59	37,25	√		26,59	√		√	√	
C30312-75		32,83	45,97	√		32,83	√		√	√	
C30312-100		37,41	52,37	√		37,41	√		√	√	

Referencia	Dentados - P.V.P.										
	1	2	3	4	5	6	6+TiAlN	7	8	9	10
C60312		28,34				28,34	39,91				
C60413		27,01				27,01	39,18				
C60516		22,86				22,86	38,21				
C60618	√	23,53	31,19	√		22,43	34,10		√	√	√
C60625		32,34				32,34	44,81				
C60820	√	25,70	32,72	√	30,84	26,20	38,28		√	√	√
C61020	√	30,79	34,64	√	34,84	30,49	46,48	√	√	√	√
C61025		34,51				34,51	49,55				
C61125		41,09		√		41,09	58,30		√	√	
C61210		44,52				44,52	59,09				
C61220		45,70		√		43,99	63,48		√	√	
C61225	√	43,59	54,47	√	49,82	43,59	64,39	√	√	√	√
C61525	√	54,81	71,21	√	62,64	55,87	79,37	√	√	√	√
C62025		92,14	102,25	√		92,14	118,12		√	√	√
C62525		119,31	158,66			119,31	180,55				
C60618-100		66,08	92,50			66,08	√		√	√	
C60618-150		85,19	119,27			85,19	√		√	√	
C60820-170		35,72	52,37			35,72	√		√	√	
C61020-170		42,38	57,60			41,59	√		√	√	
C61225-175		67,29	90,51			64,15	√		√	√	

Referencia	Dentados - P.V.P.										
	1	2	3	4	5	6	6+TiAlN	7	8	9	10
C81225	√	45,28	56,58	√	49,82	45,28	64,39	√	√	√	√
C81525	√	56,93	71,21	√		55,87	79,37	√	√	√	√
C82025		92,14	102,25	√		92,14	118,12		√	√	√
C82525		119,31	158,66			119,31	180,55				

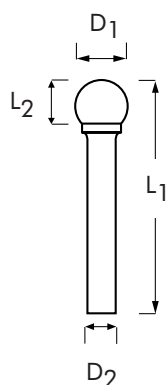

**TIPO  
D**

**TiAlN**

3 mm. MANGO

Referencia	Dimensiones - En mm				
	D <sub>1</sub>	L <sub>2</sub>	D <sub>2</sub>	L <sub>1</sub>	Tipo
D30202	2.0	1.8	3	38	Monobloc
D30302	2.5	2.3	3	38	Monobloc
D30303	3.0	2.5	3	38	Monobloc
D30404	4.0	3.4	3	38	Monobloc
D30505	5.0	4.7	3	38	Monobloc
D30606	6.3	5.0	3	38	Soldada
<b>SERIE LARGA</b>					
D30303-50	3.0	2.7	3	50	Monobloc
D30303-75	3.0	2.7	3	75	Monobloc

6 mm. MANGO

Referencia	Dimensiones - En mm				
	D <sub>1</sub>	L <sub>2</sub>	D <sub>2</sub>	L <sub>1</sub>	Tipo
D60303	3.0	2.5	6	50	Monobloc
D60404	4.0	3.0	6	50	Monobloc
D60505	5.0	4.0	6	50	Monobloc
D60606	6.0	4.7	6	50	Monobloc
D60808	8.0	6.0	6	52	Soldada
D61010	9.6	8.0	6	54	Soldada
D61111	11.0	9.5	6	55	Soldada
D61212	12.7	11.0	6	56	Soldada
D61515	16.0	14.0	6	59	Soldada
D62020	19.0	16.5	6	62	Soldada
D62525	25.0	22.0	6	67	Soldada
<b>SERIE LARGA</b>					
D60808-180	8.0	7.0	6	180	Soldada
D61010-185	9.6	8.5	6	185	Soldada
D61212-162	12.5	11.4	6	162	Soldada

8 mm. MANGO

Referencia	Dimensiones - En mm				
	D <sub>1</sub>	L <sub>2</sub>	D <sub>2</sub>	L <sub>1</sub>	Tipo
D81212	12.7	11.0	8	56	Soldada
D81515	16.0	14.0	8	59	Soldada
D82020	19.0	16.5	8	62	Soldada
D82525	25.0	22.0	8	67	Soldada



## PUNTA BOLA O ESFÉRICA

EN STOCK: Exclusivamente los diámetros y dentados tarifados.

Los diámetros y dentados punteados no se encuentran en stock, pero se pueden suministrar bajo demanda con los siguientes recargos:

- Dentados 1, 4 y 5 recargo 10% sobre tarifa dentado n°6
- Dentado 7, 8, 9 y 10 recargo 20% sobre tarifa dentado n°6



Los diámetros y dentados cuyas casillas figuren en blanco (sin precios y sin punteo) se suministran con oferta previa de precio y plazo.

Referencia	Dentados - P.V.P.										
	1	2	3	4	5	6	6+TiAlN	7	8	9	10
D30202		13,43		√		13,43	19,77		√	√	
D30302		12,58				12,58	18,36				
D30303		10,62	17,32	√		10,72	18,03		√	√	
D30404		26,54	31,19	√		26,54	34,94		√	√	
D30505		29,48				29,48	44,13				
D30606		16,93	26,55	√		16,93	28,39		√	√	
D30303-50		23,68	33,16	√		23,68	√		√	√	
D30303-75		29,09	40,72	√		29,09	√		√	√	

Referencia	Dentados - P.V.P.										
	1	2	3	4	5	6	6+TiAlN	7	8	9	10
D60303		29,62				29,62					
D60404		25,87				25,87					
D60505		22,51				22,51					
D60606	√	19,29	28,65	√		19,85	30,46		√	√	√
D60808	√	21,54	26,41	√		21,54	33,22		√	√	√
D61010	√	24,10	28,67	√	26,01	23,42	38,45	√	√	√	√
D61111		31,86		√		31,86	49,08		√	√	
D61212		31,25	38,71	√	35,04	31,55	50,07		√	√	√
D61515	√	40,20	49,37	√		40,20	61,88	√	√	√	√
D62020	√	55,53	68,21	√		55,53	80,49	√	√	√	√
D62525		104,97	135,18	√		104,97	136,31		√	√	
D60808-180		28,79	42,22			28,79	√		√	√	
D61010-185		34,20	47,21			34,20	√		√	√	
D61212-162		48,31	63,74			46,50	√		√	√	

Referencia	Dentados - P.V.P.										
	1	2	3	4	5	6	6+TiAlN	7	8	9	10
D81212		32,46	39,86	√		32,46	50,07		√	√	√
D81515	√	40,20	49,38	√		40,20	61,88	√	√	√	√
D82020	√	55,53	68,21	√		55,53	80,49	√	√	√	√
D82525		104,97	135,18	√		104,97	136,31		√	√	

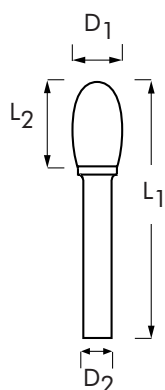

**TIPO  
E**

**TAIN**

3 mm. MANGO

Referencia	Dimensiones - En mm				
	D <sub>1</sub>	L <sub>2</sub>	D <sub>2</sub>	L <sub>1</sub>	Tipo
E30306	3.0	6.0	3	38	Monobloc
E30508	5.0	8.0	3	38	Monobloc
E30610	6.3	9.5	3	42	Soldada
<b>SERIE LARGA</b>					
E30306-50	3.0	6.0	3	50	Monobloc
E30306-75	3.0	6.0	3	75	Monobloc

6 mm. MANGO

Referencia	Dimensiones - En mm				
	D <sub>1</sub>	L <sub>2</sub>	D <sub>2</sub>	L <sub>1</sub>	Tipo
E60610	6.0	10.0	6	50	Monobloc
E60815	8.0	15.0	6	60	Soldada
E61015	9.6	16.0	6	60	Soldada
E61220	12.7	22.0	6	67	Soldada
E61525	16.0	25.0	6	70	Soldada
E62025	19.0	25.0	6	70	Soldada
<b>SERIE LARGA</b>					
E61015-165	9.6	16.0	6	165	Soldada
E61220-170	12.7	22.0	6	170	Soldada

8 mm. MANGO

Referencia	Dimensiones - En mm				
	D <sub>1</sub>	L <sub>2</sub>	D <sub>2</sub>	L <sub>1</sub>	Tipo
E81220	12.7	22.0	8	67	Soldada
E81525	16.0	25.0	8	70	Soldada
E82025	19.0	25.0	8	70	Soldada



93 699 46 04



pedidos@suministrosrado.com www.suministrosrado.com



## PUNTA OVAL O GOTA



EN STOCK: Exclusivamente los diámetros y dentados tarifados.

Los diámetros y dentados punteados no se encuentran en stock, pero se pueden suministrar bajo demanda con los siguientes recargos:

- Dentados 1, 4 y 5 recargo 10% sobre tarifa dentado n°6
- Dentado 7, 8, 9 y 10 recargo 20% sobre tarifa dentado n°6

Los diámetros y dentados cuyas casillas figuren en blanco (sin precios y sin punteo) se suministran con oferta previa de precio y plazo.

Referencia	Dentados - P.V.P.										
	1	2	3	4	5	6	6+TiAlN	7	8	9	10
E30306		12,08	19,50	√		12,08	19,77		√	√	
E30508		25,53				25,53	37,64				
E30610		17,24	26,30	√		17,58	28,38		√	√	
E30306-50		30,84				30,84					
E30306-75		35,37				35,37					

Referencia	Dentados - P.V.P.										
	1	2	3	4	5	6	6+TiAlN	7	8	9	10
E60610	√	21,64	31,54	√		22,71	35,14		√	√	
E60815		24,57	34,70	√		25,29	38,35		√	√	
E61015	√	27,92	33,01	√	31,62	28,74	41,95		√	√	√
E61220	√	40,94	52,73	√	46,37	40,94	60,86		√	√	√
E61525	√	56,88	73,23	√		56,88	81,41		√	√	√
E62025		78,62	98,40	√		78,62	105,62		√	√	
E61015-165		48,98				48,98					
E61220-170		63,73				63,73					

Referencia	Dentados - P.V.P.										
	1	2	3	4	5	6	6+TiAlN	7	8	9	10
E81220	√	42,95	52,73	√	46,37	42,16	60,86		√	√	√
E81525	√	59,66	73,23	√	64,42	59,66	81,41		√	√	√
E82025		78,62	98,40	√		78,62	105,62		√	√	

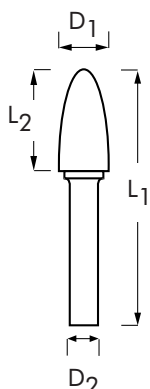
**TIPO  
F**

**TRAIN**

3 mm. MANGO

Referencia	Dimensiones - En mm				
	D <sub>1</sub>	L <sub>2</sub>	D <sub>2</sub>	L <sub>1</sub>	Tipo
F30306	3.0	6.0	3	38	Monobloc
F30308	3.0	8.0	3	38	Monobloc
F30312	3.0	14.0	3	38	Monobloc
F30512	5.0	12.7	3	38	Monobloc
F30612	6.3	12.7	3	45	Soldada
<b>SERIE LARGA</b>					
F30312-50	3.0	14.0	3	50	Monobloc
F30312-75	3.0	14.0	3	75	Monobloc

6 mm. MANGO

Referencia	Dimensiones - En mm				
	D <sub>1</sub>	L <sub>2</sub>	D <sub>2</sub>	L <sub>1</sub>	Tipo
F60618	6.0	18.0	6	50	Monobloc
F60820	8.0	20.0	6	65	Soldada
F61020	9.6	19.0	6	64	Soldada
F61125	11.0	25.0	6	70	Soldada
F61220	12.7	19.0	6	64	Soldada
F61225	12.7	25.0	6	70	Soldada
F61525	16.0	25.0	6	70	Soldada
F61530	16.0	30.0	6	75	Soldada
F62025	19.0	25.0	6	70	Soldada
F62032	19.0	32.0	6	77	Soldada
F62038	19.0	38.0	6	83	Soldada
<b>SERIE LARGA</b>					
F60618-150	6.0	18.0	6	150	Monobloc
F61020-170	9.6	19.2	6	170	Soldada
F61225-175	12.5	25.4	6	175	Soldada

8 mm. MANGO

Referencia	Dimensiones - En mm				
	D <sub>1</sub>	L <sub>2</sub>	D <sub>2</sub>	L <sub>1</sub>	Tipo
F81225	12.7	25.0	8	70	Soldada
F81525	16.0	25.0	8	70	Soldada
F82025	19.0	25.0	8	70	Soldada
F82032	19.0	32.0	8	77	Soldada
F82038	19.0	38.0	8	83	Soldada



EN STOCK: Exclusivamente los diámetros y dentados tarifados.

Los diámetros y dentados punteados no se encuentran en stock, pero se pueden suministrar bajo demanda con los siguientes recargos:

- Dentados 1, 4 y 5 recargo 10% sobre tarifa dentado n°6
- Dentado 7, 8, 9 y 10 recargo 20% sobre tarifa dentado n°6

Los diámetros y dentados cuyas casillas figuren en blanco (sin precios y sin punteo) se suministran con oferta previa de precio y plazo.

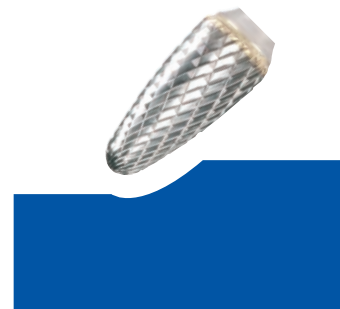

Referencia	Dentados - P.V.P.										
	1	2	3	4	5	6	6+TiAlN	7	8	9	10
F30306		21,76				21,76	29,62				
F30308		14,63		√		14,63	20,97		√	√	
F30312		14,91	20,47	√		14,21	20,97		√	√	
F30512		26,45				26,45	37,30				
F30612		17,58	25,08	√		17,58	28,38		√	√	
F30312-50		27,42	38,38	√		27,42	36,51		√	√	
F30312-75		32,78				32,78					

Referencia	Dentados - P.V.P.										
	1	2	3	4	5	6	6+TiAlN	7	8	9	10
F60618	√	22,76	32,57	√		21,70	33,13		√	√	
F60820	√	26,27	32,87	√		26,27	38,35		√	√	
F61020	√	33,05	34,85	√	36,36	32,42	47,85	√	√	√	
F61125		41,64		√		41,64	58,86		√	√	
F61220		41,01		√		41,01	59,20		√	√	
F61225	√	41,25	50,65	√	45,82	42,04	60,75	√	√	√	
F61525	√	58,58	73,27	√	63,25	56,39	79,92	√	√	√	
F61530		64,47				67,63	93,22				
F62025		75,65	94,62	√		75,65	101,63		√	√	
F62032		105,03	120,10	√		105,03	136,35		√	√	
F62038		133,27	158,40	√		133,27	164,61		√	√	
F60618-150		63,57	90,61			63,57	√		√	√	
F61020-170		40,88	56,36		47,66	40,88	√		√	√	
F61225-175		63,43	83,28		65,18	60,47					

Referencia	Dentados - P.V.P.										
	1	2	3	4	5	6	6+TiAlN	7	8	9	10
F81225	√	42,44	52,15	√	45,82	42,44	60,75	√	√	√	√
F81525	√	58,58	71,91	√	63,25	58,58	79,92	√	√	√	√
F82025		75,65	94,62	√		75,65	101,63		√	√	√
F82032		105,03	120,10	√		105,03	136,35		√	√	√
F82038		133,27	158,40	√		133,27	164,61		√	√	√

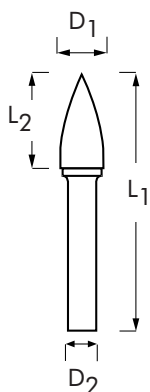
**TIPO  
G**

**TAIN**

**3 mm. MANGO**

Referencia	Dimensiones - En mm				
	D <sub>1</sub>	L <sub>2</sub>	D <sub>2</sub>	L <sub>1</sub>	Tipo
G30306	3.0	6.0	3	38	Monobloc
G30310	3.0	10.0	3	38	Monobloc
G30312	3.0	14.0	3	38	Monobloc
G30512	5.0	12.7	3	38	Monobloc
G30612	6.3	12.7	3	45	Soldada
<b>SERIE LARGA</b>					
G30312-50	3.0	14.0	3	50	Monobloc
G30312-75	3.0	14.0	3	75	Monobloc

**6 mm. MANGO**

Referencia	Dimensiones - En mm				
	D <sub>1</sub>	L <sub>2</sub>	D <sub>2</sub>	L <sub>1</sub>	Tipo
G60618	6.0	18.0	6	50	Monobloc
G60820	8.0	19.0	6	64	Soldada
G61020	9.6	19.0	6	64	Soldada
G61220	12.7	19.0	6	64	Soldada
G61225	12.7	25.0	6	70	Soldada
G61230	12.7	30.0	6	75	Soldada
G61525	16.0	25.0	6	70	Soldada
G61530	16.0	30.0	6	75	Soldada
G62025	19.2	25.0	6	70	Soldada
G62038	19.2	38.0	6	83	Soldada
<b>SERIE LARGA</b>					
G61020-170	9.6	19.2	6	170	Soldada
G61225-175	12.5	25.4	6	175	Soldada

**8 mm. MANGO**

Referencia	Dimensiones - En mm				
	D <sub>1</sub>	L <sub>2</sub>	D <sub>2</sub>	L <sub>1</sub>	Tipo
G81225	12.7	25.0	8	70	Soldada
G81230	12.7	30.0	8	75	Soldada
G81525	16.0	25.0	8	70	Soldada
G81630	16.0	30.0	8	75	Soldada
G82025	19.0	25.0	8	70	Soldada
G82038	19.0	38.0	8	83	Soldada





## FORMA OJIVAL EN PUNTA

EN STOCK: Exclusivamente los diámetros y dentados tarifados.

Los diámetros y dentados punteados no se encuentran en stock, pero se pueden suministrar bajo demanda con los siguientes recargos:

- Dentados 1, 4 y 5 recargo 10% sobre tarifa dentado n°6
- Dentado 7, 8, 9 y 10 recargo 20% sobre tarifa dentado n°6

Los diámetros y dentados cuyas casillas figuren en blanco (sin precios y sin punteo) se suministran con oferta previa de precio y plazo.



Referencia	Dentados - P.V.P.										
	1	2	3	4	5	6	6+TiAlN	7	8	9	10
G30306		13,43		√		13,43	19,77		√	√	
G30310		13,75				13,75	20,43				
G30312		14,21	20,29	√		13,93	20,97		√	√	
G30512		26,38				26,38	37,64				
G30612		17,91	24,74	√		17,91	28,38		√	√	
G30312-50		24,51	34,34	√		24,51	√		√	√	
G30312-75		30,76	43,05	√		30,76	√		√	√	

Referencia	Dentados - P.V.P.										
	1	2	3	4	5	6	6+TiAlN	7	8	9	10
G60618	√	21,11	36,40	√		21,73	33,15		√	√	
G60820		24,38	39,15	√		24,86	39,19		√	√	
G61020	√	28,75	47,13	√	35,17	29,32	46,77		√	√	
G61220		40,83		√		39,69	59,03		√	√	
G61225	√	37,64	52,98	√	46,04	38,01	60,97	√	√	√	
G61230		67,62		√		67,62	90,05		√	√	
G61525		57,39	82,02	√		55,25	82,84		√	√	
G61530		80,12		√		80,12	115,07		√	√	
G62025		89,09		√		89,09	115,07		√	√	
G62038		125,10		√		125,10	156,44		√	√	
G61020-170		43,32	60,17			43,32	√		√	√	
G61225-175		61,50	81,78			58,63	√		√	√	

Referencia	Dentados - P.V.P.										
	1	2	3	4	5	6	6+TiAlN	7	8	9	10
G81225	√	39,48		√	46,04	39,48	60,97	√	√	√	
G81230		67,62		√		67,62	90,05		√	√	
G81525		57,39		√		57,39	82,84		√	√	
G81630		84,05		√		84,05	115,07		√	√	
G82025		89,09		√		89,09	115,07		√	√	
G82038		125,10		√		125,10	156,44		√	√	

TIPO  
H

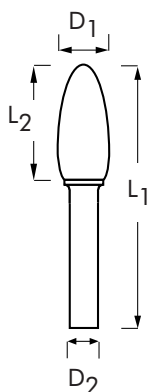

TAIN

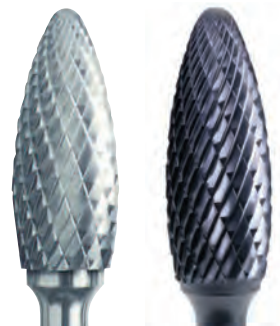

3 mm. MANGO

Referencia	Dimensiones - En mm				
	D <sub>1</sub>	L <sub>2</sub>	D <sub>2</sub>	L <sub>1</sub>	Tipo
H30306	3.0	6.0	3	38	Monobloc
H30510	5.0	9.5	3	38	Monobloc
H30612	6.0	10.0	3	43	Soldada

6 mm. MANGO

Referencia	Dimensiones - En mm				
	D <sub>1</sub>	L <sub>2</sub>	D <sub>2</sub>	L <sub>1</sub>	Tipo
H60614	6.0	14.0	6	50	Monobloc
H60820	8.0	19.0	6	64	Soldada
H61020	10.0	19.0	6	65	Soldada
H61232	12.7	32.0	6	77	Soldada
H61535	16.0	36.0	6	81	Soldada
H62042	19.0	41.0	6	86	Soldada

8 mm. MANGO

Referencia	Dimensiones - En mm				
	D <sub>1</sub>	L <sub>2</sub>	D <sub>2</sub>	L <sub>1</sub>	Tipo
H81232	12.7	32.0	8	77	Soldada
H81535	16.0	36.0	8	81	Soldada
H82042	19.0	41.0	8	86	Soldada

## FORMA LLAMA

EN STOCK: Exclusivamente los diámetros y dentados tarifados.

Los diámetros y dentados punteados no se encuentran en stock, pero se pueden suministrar bajo demanda con los siguientes recargos:

- Dentados 1, 4 y 5 recargo 10% sobre tarifa dentado n°6
- Dentado 7, 8, 9 y 10 recargo 20% sobre tarifa dentado n°6

Los diámetros y dentados cuyas casillas figuren en blanco (sin precios y sin punteo) se suministran con oferta previa de precio y plazo.



Referencia	Dentados - P.V.P.										
	1	2	3	4	5	6	6+TiAlN	7	8	9	10
H30306		13,78		√		13,78	20,00		√	√	
H30510		27,43				27,43	36,67				
H30612		18,22				18,22	24,85				

Referencia	Dentados - P.V.P.										
	1	2	3	4	5	6	6+TiAlN	7	8	9	10
H60614		24,22				24,22	35,29				
H60820	√	26,55	39,24	√		26,81	41,60		√	√	
H61020		53,18	60,33			53,18	72,11				
H61232	√	55,27	79,61	√	66,30	54,19	78,46		√	√	
H61535		83,16	107,86	√		79,27	112,40		√	√	
H62042		118,63		√		118,63	149,96		√	√	

Referencia	Dentados - P.V.P.										
	1	2	3	4	5	6	6+TiAlN	7	8	9	10
H81232	√	57,98		√	66,30	57,98	78,46		√	√	
H81535		83,16		√		83,16	112,40		√	√	
H82042		118,63		√		118,63	149,96		√	√	

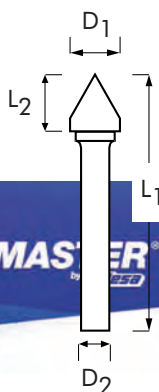
**TIPO  
J**

**TIPO  
K**

**TiAlN**

**3 mm. MANGO**

Referencia	Dimensiones - En mm					Tipo	Ángulo
	D <sub>1</sub>	L <sub>2</sub>	D <sub>2</sub>	L <sub>1</sub>			
J30303	3.0	2.5	3	38	Monobloc	60°	
K30303	3.0	1.5	3	38	Monobloc	90°	

**6 mm. MANGO**

Referencia	Dimensiones - En mm					Tipo	Ángulo
	D <sub>1</sub>	L <sub>2</sub>	D <sub>2</sub>	L <sub>1</sub>			
J60606	6.0	4.0	6	50	Monobloc	60°	
J61008	9.6	8.0	6	56	Soldada	60°	
J61210	12.7	11.0	6	59	Soldada	60°	
J61512	16.0	14.5	6	63	Soldada	60°	
J62018	19.0	17.5	6	65	Soldada	60°	
J62520	25.0	24.5	6	70	Soldada	60°	
K60603	6.0	3.0	6	50	Monobloc	90°	
K61004	9.6	4.7	6	53	Soldada	90°	
K61206	12.7	6.3	6	55	Soldada	90°	
K61508	16.0	8.0	6	57	Soldada	90°	
K62012	19.0	9.5	6	59	Soldada	90°	
K62512	25.0	12.7	6	61	Soldada	90°	

**8 mm. MANGO**

Referencia	Dimensiones - En mm					Tipo	Ángulo
	D <sub>1</sub>	L <sub>2</sub>	D <sub>2</sub>	L <sub>1</sub>			
J81210	12.7	11.0	8	59	Soldada	60°	
J81512	16.0	14.5	8	63	Soldada	60°	
J82018	19.0	17.5	8	65	Soldada	60°	
J82520	25.0	24.5	8	70	Soldada	60°	
K81206	12.7	6.3	8	55	Soldada	90°	
K81508	16.0	8.0	8	57	Soldada	90°	
K82012	19.0	9.5	8	59	Soldada	90°	
K82512	25.0	12.7	8	61	Soldada	90°	



## PUNTA CÓNICA 60° Y 90°

EN STOCK: Exclusivamente los diámetros y dentados tarifados.

Los diámetros y dentados punteados no se encuentran en stock, pero se pueden suministrar bajo demanda con los siguientes recargos:

- Dentados 1, 4 y 5 recargo 10% sobre tarifa dentado n°6
- Dentado 7, 8, 9 y 10 recargo 20% sobre tarifa dentado n°6

Los diámetros y dentados cuyas casillas figuren en blanco (sin precios y sin punteo) se suministran con oferta previa de precio y plazo.

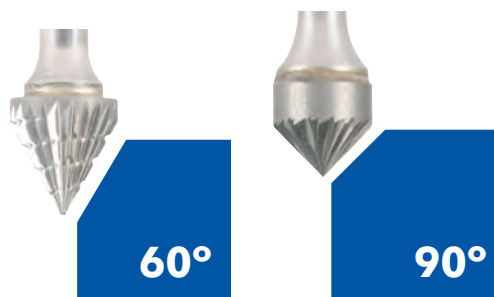

Referencia	Dentados - P.V.P.										
	1	2	3	4	5	6	6+TiAlN	7	8	9	10
J30303		10,75				10,75	17,09			√	
K30303		10,69				10,69	17,02			√	

Referencia	Dentados - P.V.P.										
	1	2	3	4	5	6	6+TiAlN	7	8	9	10
J60606		19,67				19,67	30,46			√	
J61008		25,70				25,70	40,50			√	
J61210		31,23				31,23	49,44			√	
J61512		46,99				46,99	69,42			√	
J62018		59,73				59,73	85,70			√	
J62520		93,68				93,68	114,56			√	
K60603		19,67				19,67	30,46			√	
K61004		25,46				24,27	40,50			√	
K61206		31,23				31,23	49,44			√	
K61508		44,33				42,26	69,42			√	
K62012		61,27				61,27	87,25			√	
K62512		93,68				93,68	114,61			√	

Referencia	Dentados - P.V.P.										
	1	2	3	4	5	6	6+TiAlN	7	8	9	10
J81210		31,23				31,23	49,44			√	
J81512		46,99				46,99	69,42			√	
J82018		59,73				59,73	85,70			√	
J82520		93,68				93,68	114,56				
K81206		31,23				31,23	49,44			√	
K81508		44,33				44,33	69,42			√	
K82012		61,27				61,27	87,25			√	
K82512		93,68				93,68	114,61				

TIPO  
L

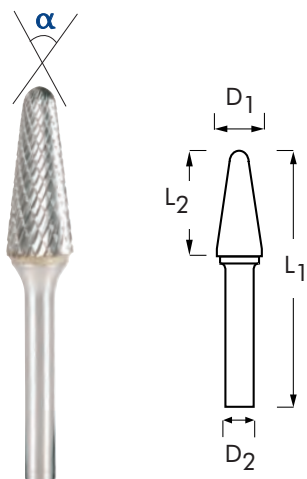

TiAlN



3 mm. MANGO

Referencia	Dimensiones - En mm					Tipo	Ángulo
	D <sub>1</sub>	L <sub>2</sub>	D <sub>2</sub>	L <sub>1</sub>			
L30310	3.0	10.0	3	38	Monobloc	10°	
L30312	3.0	14.0	3	38	Monobloc	8°	
L30512	5.0	12.7	3	38	Monobloc	14°	
L30612	6.3	15.8	3	48	Soldada	22°	

6 mm. MANGO

Referencia	Dimensiones - En mm					Tipo	Ángulo
	D <sub>1</sub>	L <sub>2</sub>	D <sub>2</sub>	L <sub>1</sub>			
L60618	6.0	18.0	6	50	Monobloc	14°	
L60822	8.0	25.4	6	70	Soldada	14°	
L61020	10.0	20.0	6	65	Soldada	14°	
L61026	9.6	30.0	6	76	Soldada	14°	
L61225	12.0	25.0	6	70	Soldada	14°	
L61228	12.7	32.0	6	77	Soldada	14°	
L61533	16.0	33.0	6	78	Soldada	14°	
L62038	19.0	41.0	6	86	Soldada	14°	
<b>SERIE LARGA</b>							
L61026-176	9.6	30.2	6	176	Soldada	14°	
L61228-182	12.5	32.0	6	182	Soldada	14°	

8 mm. MANGO

Referencia	Dimensiones - En mm					Tipo	Ángulo
	D <sub>1</sub>	L <sub>2</sub>	D <sub>2</sub>	L <sub>1</sub>			
L81228	12.7	32.0	8	77	Soldada	14°	
L81533	16.0	33.0	8	78	Soldada	14°	
L82038	19.0	41.0	8	86	Soldada	14°	

## CÓNICA REDONDEADA

EN STOCK: Exclusivamente los diámetros y dentados tarifados.

Los diámetros y dentados punteados no se encuentran en stock, pero se pueden suministrar bajo demanda con los siguientes recargos:

- Dentados 1, 4 y 5 recargo 10% sobre tarifa dentado n°6
- Dentado 7, 8, 9 y 10 recargo 20% sobre tarifa dentado n°6

Los diámetros y dentados cuyas casillas figuren en blanco (sin precios y sin punteo) se suministran con oferta previa de precio y plazo.

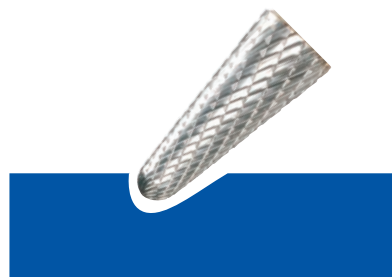

Referencia	Dentados - P.V.P.										
	1	2	3	4	5	6	6+TiAlN	7	8	9	10
L30310		13,69		√		13,69	19,77		√	√	
L30312		12,08	20,43	√		12,20	19,77		√	√	
L30512		30,16				30,16	43,77				
L30612		19,78	32,75	√		20,75	34,07		√	√	

Referencia	Dentados - P.V.P.										
	1	2	3	4	5	6	6+TiAlN	7	8	9	10
L60618		22,85	34,24	√		23,07	33,65		√	√	
L60822		28,55	44,81	√	39,34	29,11	44,76		√	√	
L61020		33,99	45,36			35,65	47,53				
L61026		35,65	42,92	√	39,58	34,99	53,20	√	√	√	
L61225		41,88	51,91			43,52	59,19				
L61228		43,53	52,42	√	48,34	42,31	62,15	√	√	√	
L61533		77,81	97,31	√	95,17	77,81	112,49	√	√	√	
L62038		128,14	142,83	√		128,14	159,48		√	√	
L61026-176		52,06	72,05			52,06	√		√	√	
L61228-182		63,72	87,93			63,72	√		√	√	

Referencia	Dentados - P.V.P.										
	1	2	3	4	5	6	6+TiAlN	7	8	9	10
L81228		43,53	54,98	√	48,34	43,53	62,15	√	√	√	
L81533		81,62	108,20	√		81,62	112,49	√	√	√	
L82038		128,14	142,83	√		128,14	159,48		√	√	

TIPO  
M

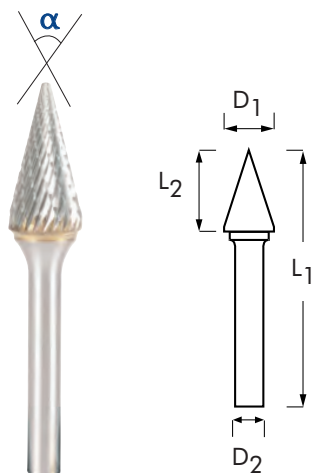

TiAlN



3 mm. MANGO

Referencia	Dimensiones - En mm					
	D <sub>1</sub>	L <sub>2</sub>	D <sub>2</sub>	L <sub>1</sub>	Tipo	Ángulo
M30308	3.0	8.0	3	38	Monobloc	18°
M30311	3.0	11.0	3	38	Monobloc	14°
M30315	3.0	15.0	3	38	Monobloc	10°
M30612	6.3	12.7	3	49	Soldada	22°

6 mm. MANGO

Referencia	Dimensiones - En mm					
	D <sub>1</sub>	L <sub>2</sub>	D <sub>2</sub>	L <sub>1</sub>	Tipo	Ángulo
M60612	6.0	12.7	6	50	Monobloc	20°
M60620	6.0	20.0	6	50	Monobloc	14°
M60625	6.0	25.0	6	50	Monobloc	10°
M60818	8.0	18.0	6	64	Soldada	22°
M61020	9.6	16.0	6	64	Soldada	28°
M61222	12.7	22.0	6	71	Soldada	28°
M61525	16.0	25.0	6	71	Soldada	31°

8 mm. MANGO

Referencia	Dimensiones - En mm					
	D <sub>1</sub>	L <sub>2</sub>	D <sub>2</sub>	L <sub>1</sub>	Tipo	Ángulo
M81222	12.7	22.0	8	71	Soldada	28°
M81525	16.0	25.0	8	71	Soldada	31°

## FORMA CÓNICA EN PUNTA

EN STOCK: Exclusivamente los diámetros y dentados tarifados.

Los diámetros y dentados punteados no se encuentran en stock, pero se pueden suministrar bajo demanda con los siguientes recargos:

- Dentados 1, 4 y 5 recargo 10% sobre tarifa dentado nº6
- Dentado 7, 8, 9 y 10 recargo 20% sobre tarifa dentado nº6



Los diámetros y dentados cuyas casillas figuren en blanco (sin precios y sin punteo) se suministran con oferta previa de precio y plazo.

Referencia	Dentados - P.V.P.										
	1	2	3	4	5	6	6+TiAlN	7	8	9	10
M30308		13,43		√		13,43	19,77		√	√	
M30311		15,30	23,71	√		14,59	21,94		√	√	
M30315		15,60		√		15,60	21,94		√	√	
M30612	√	16,13	28,57	√		16,60	29,66		√	√	

Referencia	Dentados - P.V.P.										
	1	2	3	4	5	6	6+TiAlN	7	8	9	10
M60612		25,17				25,17	30,79				
M60620	√	20,55	35,37	√		21,56	34,94		√	√	
M60625		27,43				27,43	41,05				
M60818		29,57				31,02	47,53				
M61020	√	32,43	45,36	√	39,66	31,79	50,86		√	√	
M61222		40,61	57,95	√	49,67	39,81	64,25		√	√	
M61525		60,76		√		63,74	93,54		√	√	

Referencia	Dentados - P.V.P.										
	1	2	3	4	5	6	6+TiAlN	7	8	9	10
M81222		42,60		√	49,67	42,60	64,25		√	√	
M81525		63,74		√		63,74	93,54		√	√	

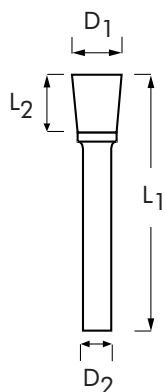

**TIPO  
N**

Ejemplo:



N30304

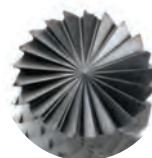

N30304E

**TiAIN**

3 mm. MANGO

Referencia	Dimensiones - En mm					
	D <sub>1</sub>	L <sub>2</sub>	D <sub>2</sub>	L <sub>1</sub>	Tipo	Ángulo
N30304	3.0	4.0	3	38	Monobloc	10°
N30304E	3.0	4.0	3	38	Monobloc	10°
N30606	6.3	6.0	3	39	Soldada	12°
N30606E	6.3	6.4	3	39	Soldada	12°

6 mm. MANGO

Referencia	Dimensiones - En mm					
	D <sub>1</sub>	L <sub>2</sub>	D <sub>2</sub>	L <sub>1</sub>	Tipo	Ángulo
N60608	6.0	8.0	6	50	Monobloc	10°
N61010	9.6	9.5	6	55	Soldada	16°
N61212	12.7	12.7	6	58	Soldada	28°
N61520	16.0	19.0	6	64	Soldada	18°
N62015	19.0	16.0	6	61	Soldada	30°

8 mm. MANGO

Referencia	Dimensiones - En mm					
	D <sub>1</sub>	L <sub>2</sub>	D <sub>2</sub>	L <sub>1</sub>	Tipo	Ángulo
N81212	12.7	12.7	8	58	Soldada	28°
N81520	16.0	19.0	8	64	Soldada	18°
N82015	19.0	16.0	8	61	Soldada	30°

## CONO INVERTIDO

EN STOCK: Exclusivamente los diámetros y dentados tarifados.

Los diámetros y dentados punteados no se encuentran en stock, pero se pueden suministrar bajo demanda con los siguientes recargos:

- Dentados 1, 4 y 5 recargo 10% sobre tarifa dentado n°6
- Dentado 7, 8, 9 y 10 recargo 20% sobre tarifa dentado n°6





Los diámetros y dentados cuyas casillas figuren en blanco (sin precios y sin punteo) se suministran con oferta previa de precio y plazo.

Referencia	Dentados - P.V.P.										
	1	2	3	4	5	6	6+TiAlN	7	8	9	10
N30304		14,03				14,03	21,94			√	
N30304E		15,99				15,99	24,44				
N30606		17,34				17,92	28,72			√	
N30606E		20,29				20,29	26,26				

Referencia	Dentados - P.V.P.										
	1	2	3	4	5	6	6+TiAlN	7	8	9	10
N60608		21,80				21,80	32,59			√	
N61010		31,83				31,83	46,64			√	
N61212		40,47				40,47	63,19			√	
N61520		57,79				57,79	80,21			√	
N62015		72,88				72,88	98,86			√	

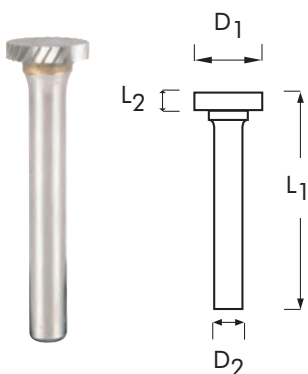
Referencia	Dentados - P.V.P.										
	1	2	3	4	5	6	6+TiAlN	7	8	9	10
N81212		42,46				42,46	63,19			√	
N81520		57,79				57,79	80,21			√	
N82015		72,88				72,88	98,86			√	

**TIPO  
PASTILLA**

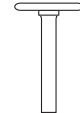
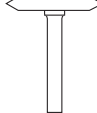
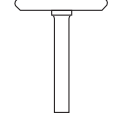
			
-	Radial	90°	90°+Radial

## 3 mm. MANGO

Referencia	Dimensiones - En mm				
	D <sub>1</sub>	L <sub>2</sub>	D <sub>2</sub>	L <sub>1</sub>	Ángulo
P31001	10.0	1.6	3	34	-

## 6 mm. MANGO

Referencia	Dimensiones - En mm				
	D <sub>1</sub>	L <sub>2</sub>	D <sub>2</sub>	L <sub>1</sub>	Ángulo
P61202	12.0	2.6	6	48	-
P62503	25.0	3.2	6	48	90° + Radial
P62505	25.0	5.5	6	50	90°
P62506	25.0	6.3	6	51	Radial
P63806	38.0	6.1	6	51	90° + Radial

## 8 mm. MANGO

Referencia	Dimensiones - En mm				
	D <sub>1</sub>	L <sub>2</sub>	D <sub>2</sub>	L <sub>1</sub>	Ángulo
P82503	25.0	3.2	8	48	90° + Radial
P82505	25.0	5.5	8	50	90°
P82506	25.0	6.3	8	51	Radial
P83806	38.0	6.1	8	51	90° + Radial

## FORMA PASTILLA

EN STOCK: Exclusivamente los diámetros y dentados tarifados.

Los diámetros y dentados punteados no se encuentran en stock, pero se pueden suministrar bajo demanda con los siguientes recargos:

- Dentados 1, 4 y 5 recargo 10% sobre tarifa dentado n°6
- Dentado 7, 8, 9 y 10 recargo 20% sobre tarifa dentado n°6

Los diámetros y dentados cuyas casillas figuren en blanco (sin precios y sin punteo) se suministran con oferta previa de precio y plazo.



Referencia	Dentados - P.V.P.											
	1	2	3	4	5	6	6+TiAlN	7	8	9	10	
P31001		31,10										

Referencia	Dentados - P.V.P.											
	1	2	3	4	5	6	6+TiAlN	7	8	9	10	
P61202		30,54										
P62503		133,73										
P62505		139,49										
P62506		118,35										
P63806		287,41										

Referencia	Dentados - P.V.P.											
	1	2	3	4	5	6	6+TiAlN	7	8	9	10	
P82503		133,73										
P82505		139,49										
P82506		118,35										
P83806		287,41										

Nueva fresa rotativa de exclusivo diseño de curva invertida que permite generar suaves radios en aristas.

Su innovador diseño provoca un efecto de autocentrado en la arista a suavizar que hace muy sencillo el manejo de la fresa en movimiento sobre la superficie de trabajo.

Fabricada en Carburo de Tungsteno sinterizado de alta calidad, garantiza un alto rendimiento y durabilidad en una amplia gama de materiales, como son el Titanio, Acero Inoxidable, Fundición, Latón, Bronce, etc...



Geometría Autocentrante



Guiado fácil y preciso



Redondea arista fácilmente

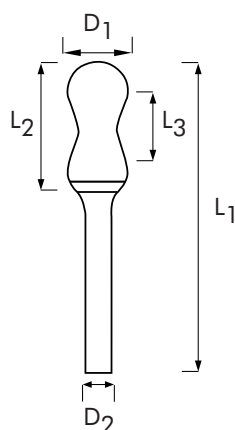

Excelente acabado superficial de la arista



Ref.	Dimensiones - En mm						
	D <sub>1</sub>	L <sub>2</sub>	L <sub>3</sub>	D <sub>2</sub>	L <sub>1</sub>	Ángulo	P.V.P.
CMN61225-2	12,8	25	16	6	70	20°	83,93



## FRESAS ROTATIVAS MICROMÉTRICAS



Dentado Standard micro para usos generales

### MATERIALES



### APLICACIONES

- Fabricantes de piezas de precisión.
- Aplicaciones en joyería.
- Fabricantes de turbinas.

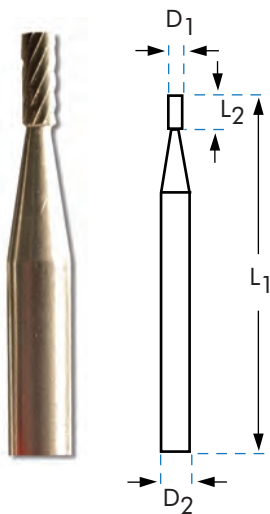

		D <sub>1</sub> mm.	L <sub>1</sub> mm.	L <sub>2</sub> mm.	D <sub>2</sub> mm.	€	
<b>TIPO A</b>	Cilíndrica serie corta	A30104-2M	1,0	38,0	4,0	3,0	20,29
		A31504-2M	1,5	38,0	4,0	3,0	20,29
		A30204-2M	2,0	38,0	4,0	3,0	20,29
<b>TIPO C</b>	Punta radial o Semiesférica	C30104-2M	1,0	38,0	4,0	3,0	20,29
		C31504-2M	1,5	38,0	4,0	3,0	20,29
		C30204-2M	2,0	38,0	4,0	3,0	20,29
<b>TIPO D</b>	Punta bola o esférica	D30101-2M	1,0	38,0	1,0	3,0	20,29
		D31515-2M	1,5	38,0	1,5	3,0	20,29
		D30202-2M	2,0	38,0	2,0	3,0	20,29
<b>TIPO E</b>	Forma oval	E31504-2M	1,5	38,0	4,0	3,0	20,29
<b>TIPO F</b>	Forma ojival redondeado	F31504-2M	1,5	38,0	4,0	3,0	20,29
<b>TIPO G</b>	Forma ojival en punta	G31504-2M	1,5	38,0	4,0	3,0	20,29
<b>TIPO M</b>	Cónica en punta	M31504-2M	1,5	38,0	4,0	3,0	20,29

Velocidad recomendada 70.000 R.P.M.

## JUEGO DE FRESAS ROTATIVAS MICROMÉTRICAS

### BSMicro

Contenido: 10 Fresas rotativas micrométricas

- |               |  |               |                                       |
|---------------|--|---------------|---------------------------------------|
| <b>TIPO A</b> | Cilíndrica serie corta:<br>A30104-2M<br>A31504-2M      | <b>TIPO E</b> | Forma oval:<br>E31504-2M              |
| <b>TIPO C</b> | Punta radial o Semiesférica:<br>C30104-2M<br>C31504-2M | <b>TIPO F</b> | Forma ojival redondeada:<br>F31504-2M |
| <b>TIPO D</b> | Punta bola o esférica:<br>D30101-2M<br>D31515-2M       | <b>TIPO G</b> | Forma ojival en punta:<br>G31504-2M   |
|               |  | <b>TIPO M</b> | Cónica en punta:<br>M31504-2M         |



P.V.P.: 188,87 €



MANGO Ø 6 mm.



REFERENCIA	PTFR31			PTFR32			PTFR33		
Nº FRESAS	10			10			10		
DENTADO	6			6			3		
CALIDAD	MD			MD			MD		AI
CONTENIDO	A61020E-6 C61225-6 G61020-6 F61225-6	A61225E-6 L61228-6 G61225-6	C61020-6 E61015-6 D61212-6	A60820E-6 C61020-6 F60820-6 L61026-6	A61020E-6 D60808-6 F61020-6	C60820-6 D61010-6 L60822-6	A60820E-3 C61020-3 F60820-3 L61228-3	A61020E-3 D60808-3 F61020-3	C60820-3 D61010-3 L61026-3
P.V.P. €	355,88			274,23			351,22		

MANGO Ø 3 mm.

MANGO Ø 6 mm.



REFERENCIA	PTFR34			PTFR35		PTFR36	
Nº FRESAS	10			5		5	
DENTADO	6			6		3	
CALIDAD	MD			MD		MD	
CONTENIDO	A30314-6 D30303-6 G30312-6 M30311-6	A30314E-6 E30306-6 H30306-6	C30312-6 F30312-6 L30312-6	A61225E-6 C61225-6 F61225-6	M61222-6 D61212-6	A61225E-3 C61225-3 F61225-3	L61228-3 D61212-3
P.V.P. €	126,52			198,62		251,87	

REFERENCIA	PTFR41		PTFR42		PTFR43		PTFR44	
Nº FRESAS	4		4		4		4	
DENTADO	6		6		6		3	
CALIDAD	MD		MD		MD		MD	
CONTENIDO	A61225-6E F61225-6	C61225-6 G61225-6	A60820-6E F60820-6	C60820-6 G60820-6	A61225-6E M61222-6	C61225-6 G61225-6	A61225-3E F61225-3	C61225-3 G61225-3
P.V.P. €	155,12		95,84		158,33		204,67	





REFERENCIA	<b>EMFR-01</b>		
Nº FRESAS	15		
CALIDAD	<b>MD</b>		
CONTENIDO	A60618-6E C60618-6 D60606-6 F60618-6 G60618-6	A61020-6E C61020-6 D61010-6 F61020-6 G61020-6	A61225-6E C61225-6 D61212-6 F61225-6 G61225-6
P.V.P. €	<b>444,46</b>		



REFERENCIA	<b>EMFR-02</b>		
Nº FRESAS	15		
CALIDAD	<b>MD</b>		
CONTENIDO	A61225-6 D61212-6 G61225-6 L61228-6	A61225-6E E61220-6 H61232-6 M60620-6	C61225-6 F61225-6 K61206-6 N61212-6
Serie Larga	A61225-6-150	C61225-6-150	F61225-6-150
P.V.P. €	<b>651,87</b>		

REFERENCIA	<b>AUTOMOCION</b>		
Nº FRESAS	8		
CALIDAD	<b>MD</b>		
CONTENIDO	A60820-6E C60820-6 D60606-6	D60808-6 E61220-6 H61232-6	L61026-6 M61020-6
P.V.P. €	<b>259,45</b>		

REFERENCIA	<b>B52</b>		
Nº FRESAS	8		
CALIDAD	<b>MD</b>		
CONTENIDO	A61225-6 C61225-6 D61212-6	E61220-6 F61225-6 G61225-6	H61232-6 M61222-6
P.V.P. €	<b>338,85</b>		



\* Bajo demanda podemos suministrar otras composiciones según sus necesidades.



<b>T12</b>
Contenido:
* 1 Ud. Amoladora 25.000 R.P.M., 0,55 HP, con accionamiento de seguridad y pinza de 6 mm. (gran rendimiento en trabajos de producción).
* 5 Uds. fresas rotativas <b>Ref. C61225-6</b>
* 5 Uds. fresas rotativas <b>Ref. F61225-6</b>
* 1 Ud. Manguera de aire con sus racores.



<b>T3</b>
Contenido:
* 1 Ud. Amoladora 75.000 R.P.M., 0,15 HP, pinza de 3 mm.
* 10 Uds. fresas rotativas. Mango 3 mm. a elegir.

P.V.P.: 804,42 €

P.V.P.: 1.025,10 €

Ref. **MINILUX-1**

MINILUX-1			
Contenido: 30 fresas rotativas de metal duro			
x 1 Uds :	A61225-6E	D61212-6	G61225-6
	C61225-6	F61225-6	L61228-6
x 2 Uds:	A60820-6E	D60808-6	G60820-6
	A61020-6E	D61010-6	G61020-6
	C60820-6	F60820-6	L60822-6
	C61020-6	F61020-6	L61026-6

Dimensiones: ancho 210 x fondo 210 x alto 210 mm.

**P.V.P.: 901,43 €**Ref. **MAXILUX-2**

MAXILUX-2			
Contenido: 180 fresas rotativas de metal duro			
x 5 Uds :	A60618-6	D60606-6	M60620-6
	A60820-6	D60808-6	M61020-6
	A61020-6	D61010-6	M61222-6
	A61225-6	D61212-6	L60618-6
	A60618-6E	F60618-6	L60822-6
	A60820-6E	F60820-6	L61026-6
	A61020-6E	F61020-6	L61228-6
	A61225-6E	F61225-6	H60820-6
	C60618-6	G60618-6	H61232-6
	C60820-6	G60820-6	E60815-6
	C61020-6	G61020-6	E61015-6
	C61225-6	G61225-6	E61220-6

Dimensiones: ancho 250 x fondo 365 x alto 235 mm.

**P.V.P.: 5.449,15 €**Ref. **BS40**

BS40			
Contenido: 40 fresas rotativas de metal duro			
x 2 Uds :	A60618-6E	F60618-6	L60618-6
	A60820-6E	F60820-6	L60822-6
	A61020-6E	F61020-6	L61026-6
	A61225-6E	F61225-6	L61228-6
	C60618-6	G60618-6	
	C60820-6	G60820-6	
	C61020-6	G61020-6	
	C61225-6	G61225-6	

Dimensiones: ancho 65 x fondo 245 x alto 300 mm.

**P.V.P.: 1.177,66 €**NOTA: El precio de los expositores vacíos: **100.00 €** netos.

93 699 46 04



pedidos@suministrosrado.com www.suministrosrado.com



## AMOLADORAS P25



Ref. **P25**

- \* Amoladora industrial, con cuerpo de acero reforzado
- \* Mando con control de seguridad
- \* Diseño Ergonómico
- \* Alto poder

	R.P.M. 6.3 BAR	POTENCIA HP	PESO Kg.	D <sub>1</sub> x L <sub>1</sub> mm.	EXTENSIÓN portafresas.	Ø mm. PINZA	SALIDA DE AIRE	OPCIÓN CAMBIO DE MOTOR	€
P25	25.000	0.55	0,60	32 x 156	No alargador	6 mm.	Adelante	SÍ	558,28
P25LR	25.000	0.55	0,70	32 x 165	No alargador	6 mm.	Adelante	SÍ	634,62
P25XLR	25.000	0.55	0,95	32 x 290	12 x 150	6 mm.	Adelante	NO	839,80
STR71	70.000	0.15	0,35	10 x 180	No alargador	3 mm.	Adelante	SÍ	638,08

### PROCURT P25 - SERVICIO DE REPARACIÓN INMEDIATO

- \* Permite al operario reparar la herramienta en 2-3 minutos.
- \* No se requiere herramienta especial.
- \* Sin pérdidas de tiempo durante la producción.

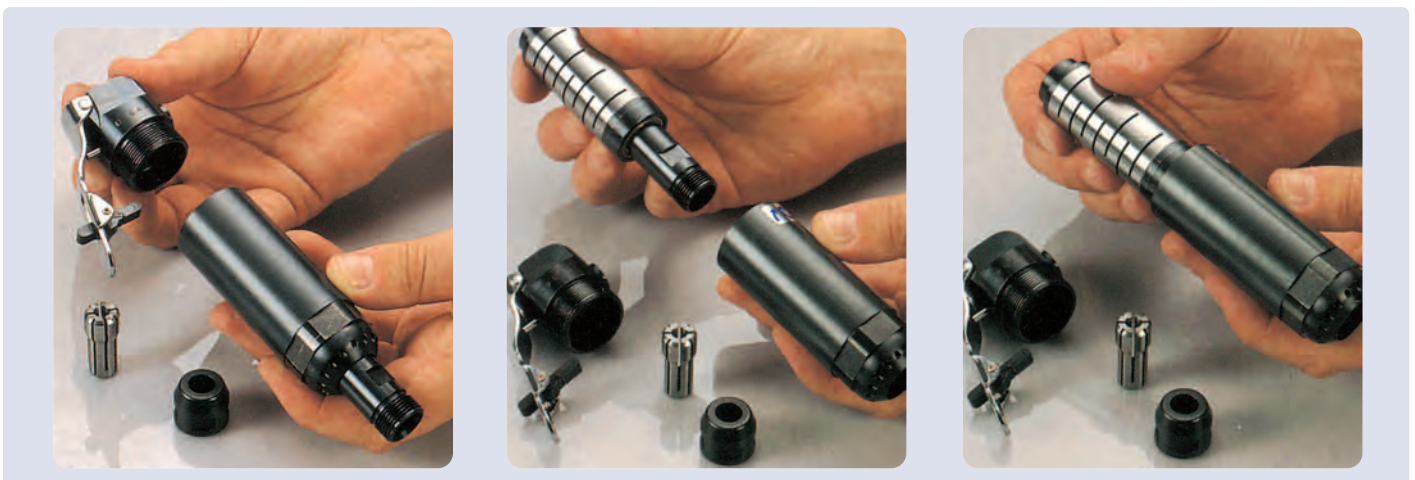

Suelte la carcasa exterior.

Reemplace el viejo motor por uno nuevo.

Monte de nuevo la carcasa exterior, y vuelva a trabajar.



Consulten tarifa de repuestos.



93 699 46 04



pedidos@suministrosrado.com www.suministrosrado.com

## DIAMANTE

## APLICACIONES

Construcción:

- Piedra, porcelánico, mármol, granito

Materiales compuestos:

- Fibra de Vidrio, fibra de carbono, poliéster, plásticos en general

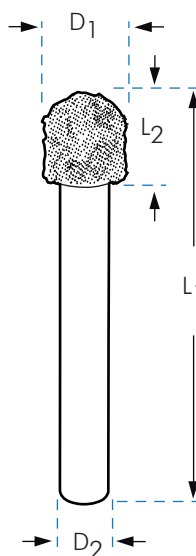
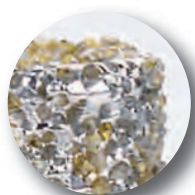
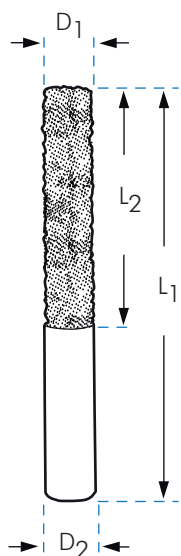

					A..D
	D <sub>1</sub> mm.	D <sub>2</sub> mm.	L <sub>1</sub> mm.	L <sub>2</sub> mm.	€
A30211D	2,40	3	38	11,00	31,46
A30314D	3,00	3	38	14,00	34,38
A30605D	6,35	3	44	4,70	34,24
A30612D	6,35	3	51	12,70	41,57
A60610D	6,00	6	50	10,00	47,86
A60820D	8,00	6	64	19,20	52,36
A80838D	8,00	8	66	38,00	75,00
A61020D	9,60	6	64	19,00	57,06
A61125D	11,00	6	70	25,40	76,32
A61220D	12,50	6	64	19,20	75,37
A61225D	12,50	6	70	25,40	78,71
A61525D	15,80	6	70	25,40	94,63
A62025D	19,20	6	70	25,40	125,69
A62525D	25,00	6	70	25,40	144,95

					C..D
	D <sub>1</sub> mm.	D <sub>2</sub> mm.	L <sub>1</sub> mm.	L <sub>2</sub> mm.	€
C30211D	2,40	3	38	11,00	35,79
C30612D	6,35	3	51	12,70	47,29
C60618D	6,00	6	50	18,00	54,45
C60820D	8,00	6	64	19,20	59,57
C60840D	8,00	6	64	38,00	67,01
C80838D	8,00	8	66	38,00	70,81
C61020D	9,60	6	64	19,20	63,91
C61011D	10,00	6	50	11,00	87,72
C61035D	10,00	6	66	35,00	68,19
C61125D	11,00	6	70	25,40	85,48
C61220D	12,50	6	64	19,20	84,42
C61225D	12,50	6	70	25,40	88,15
C61525D	15,80	6	70	25,40	105,99
C62025D	19,20	6	70	25,40	140,77
C62525D	25,00	6	70	25,40	162,34